

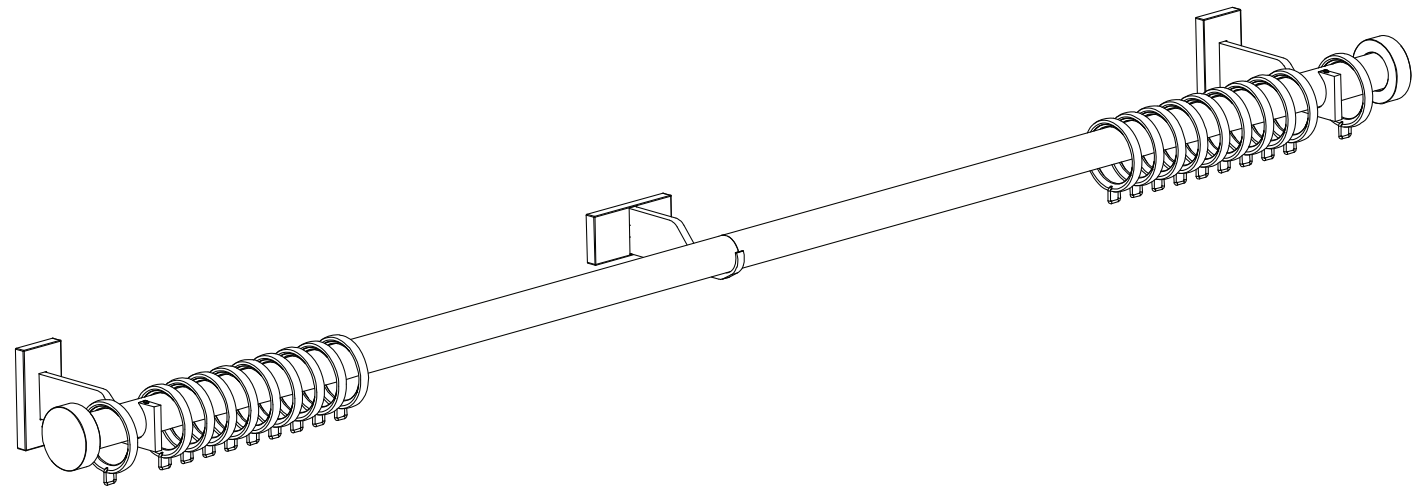

the **bradley** collection

SIMPLE

Installation Instructions



CONTACT

Web www.bradleycollection.com

Email info@bradleycollection.com

Follow     

WORLD

The Bradley Collection Ltd
Lion Barn • Maitland Road
Needham Market • Suffolk
IP6 8NS • UK

Telephone +44 (0)1449 722 724

Fax +44 (0)1449 722 728

USA & Canada

The Bradley Collection Inc.
3625 Hayden Avenue, Suite E
Culver City • CA • 90232 • USA

Telephone +1 (310) 815 8255

Fax +1 (310) 815 9255

SIMPLE

Installation Instructions

THANK YOU FOR YOUR ORDER

Before fitting this product please ensure that you have thoroughly read these instructions.

We have taken every care to design and manufacture a quality system; incorrect installation could lead to poor performance.

If any queries arise when reviewing these instructions or during installation please feel free to contact us for assistance. We will be glad to talk you through the process.

Please retain these instructions for future reference.

CONTACT

Web www.bradleycollection.com

Email info@bradleycollection.com

World +44 (0)1449 722 724

USA & Canada +1 (310) 815 8255

Follow     

Fixings

As a courtesy we have supplied a set of fixings for the system.

These screws and wall plugs are designed to be used in wood and brick walls. We understand our systems may be used on a variety of materials; drywall, aluminium and steel stud, or lath and plaster.

To properly secure a system onto these or other types of surfaces; appropriate fixings must be independently obtained.

! Assess your own wall construction and source the appropriate screw type.
! Please note that the enclosed fixings may not be suitable for all wall types.

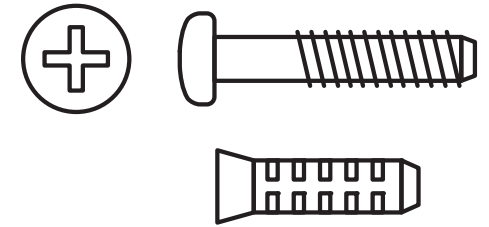

Tools

For the installation of the system the following items may be required.

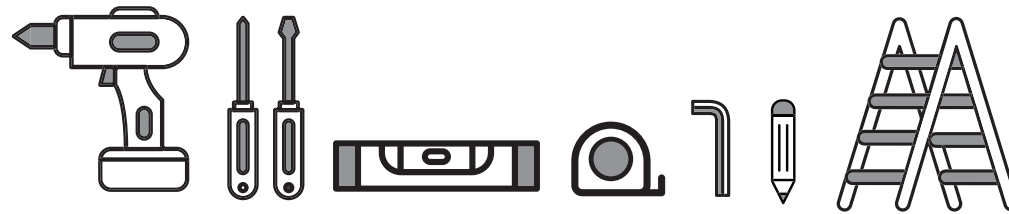

Care & Maintenance

This pole can be cleaned using a soft cloth and furniture polish.

! Please do not use any solvent or chlorine based cleaners as this will damage the finish.

 Acrylic poles should not be installed in direct sunlight or conservatories.

Bracket positioning and fixing

Side brackets should be positioned approximately 100mm (4") in from the end of the pole.

Single Brackets

To align the brackets, the top of the passing brackets should be fitted below the top of the side brackets. (see dimension Z)

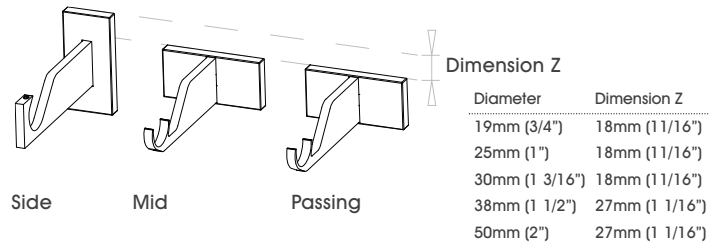

Ceiling Bracket Alignment

To align the brackets, passing ceiling brackets should be fitted in line with ceiling brackets

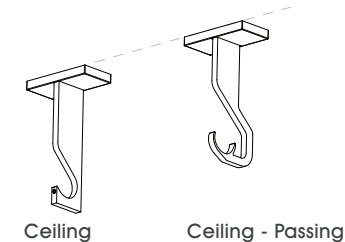

Exploded bracket assembly

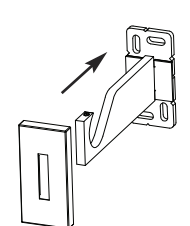

WALL FIX

Fitting Rings and Pole

Slide the curtain rings on to the pole, allowing approximately one ring for every 100mm (4"). On systems where passing rings are used ensure the open side of the ring is facing the wall.

Keep aside two rings, one for the outside of each end of the bracket.

Place the pole on the brackets, making sure that the overhangs at each end are equal. If the pole is made of two connected lengths, the mid/passing bracket should cover the join.

Recess brackets

1. Use a suitable wall fixing when attaching the plate to the wall.
2. Slide the locking sleeve over the pole then line the pole up with the all fix plate.
3. Slide the locking sleeve to the wall & lock in position by tightening the set screw.
4. Either use the ringstop if you need it to secure your drapes to the end, or use the extra set screw provided to lock the pole in place.

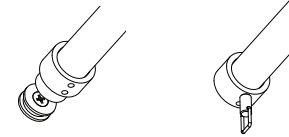

Joining the pole

Poles are supplied pre-cut to your specified lengths, in some cases the pole may be made in two or more parts, joined by a connector.

Push the joiner into the pole ends and push the poles together. Tighten the set screws at the back of the pole.

Finials

Attach the finials by pushing them into position and tightening the set screws either on the finial or at the back of the pole.

Bracket Positioning & Fixing

Side brackets should be positioned approximately 100mm (4") from the ends of the pole.

Mark the position of the brackets. For longer poles a mid/passing bracket is required. For bay window poles, passing brackets are used in conjunction with passing curtain rings.

Drill holes & insert plugs.

Screw each bracket into position.

Push coverplate into place.

Passing Brackets

The pole snaps into the passing bracket. This operation should only be done once, as repeated attempts can damage the finish.

Ensure that the pole is in the correct position first. Then gently pull the pole down whilst holding the bracket up.

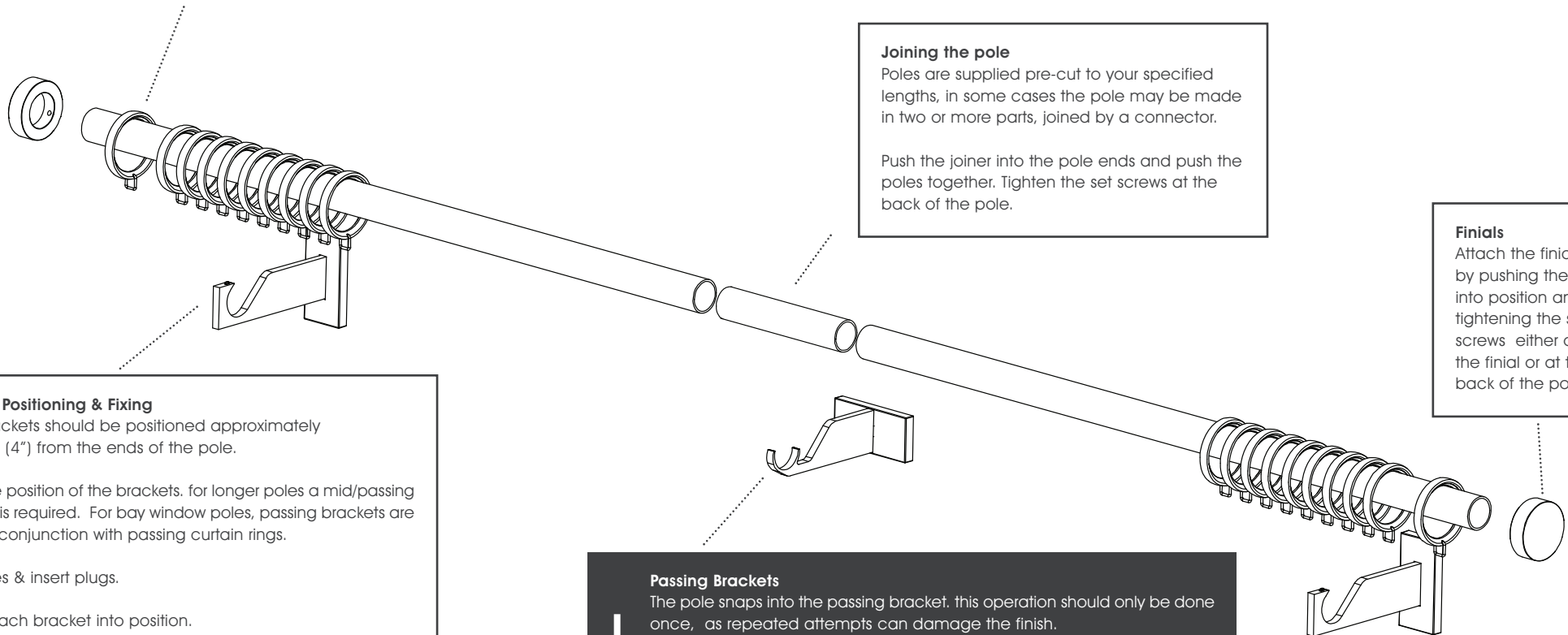

CEILING FIX

Bracket Positioning & Fixing

Ceiling brackets should be positioned approximately 100mm (4") from the ends of the pole.

Mark the position of the brackets. For longer poles a mid/passing bracket is required.
For bay window poles, passing brackets are used in conjunction with passing curtain rings.

Drill holes & insert plugs.

Screw each bracket into position.

Push coverplate into place.

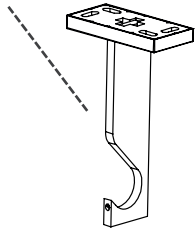

Passing Brackets

The pole snaps into the passing bracket. This operation should only be done once, as repeated attempts can damage the finish.

Ensure that the pole is in the correct position first. Then gently pull the pole down whilst holding the bracket up.

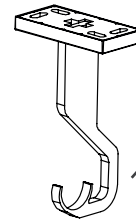

Fitting Rings and Pole

Slide the curtain rings on to the pole, allowing approximately one ring for every 100mm (4").
On systems where passing rings are used ensure the open side of the ring is facing the wall.

Keep aside two rings, one for the outside of each end of the bracket.

Place the pole on the brackets, making sure that the overhangs at each end are equal. If the pole is made of two connected lengths, the mid/passing bracket should cover the join.

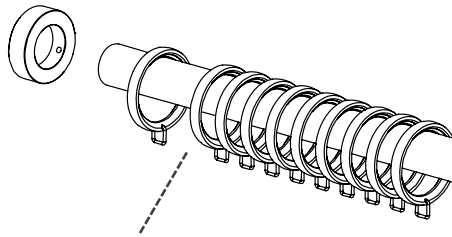

Joining the pole

Poles are supplied pre-cut to your specified lengths, in some cases the pole may be made in two or more parts, joined by a connector.

Push the joiner into the pole ends and push the poles together. Tighten the set screws at the back of the pole.

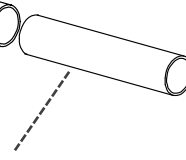

Finials

Attach the finials by pushing them into position and tightening the set screws either on the finial or at the back of the pole.

