

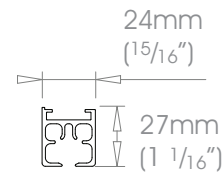

GLIDERPOLE® Corded • Round Ø30mm (1³/₁₆"

Finishes Alabaster • Dusk • Granite • Slate • Flint • Barley • Dove • Millstone • Clay • Cocoa • Cloud • Ceramic • Bone • Cream • Parchment • Damson • Moss • Smoke • Frame Grey • Raven Coat Options: Matte (M) • Satin (S) • Gloss (G) • Platinum • Champagne • Gold • Cognac • Gunmetal • Antique Brass • Pewter • Bronzed Coat Options: Satin (S) • Gloss (G)
 Natural Silver • Bright Aluminium
Custom Finishes Can be specified subject to a per colour upcharge, (up to five poles)

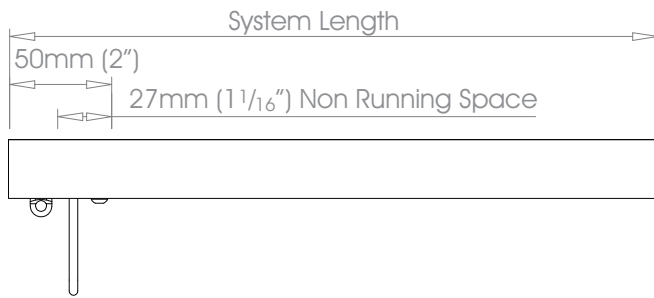



Round 30mm (1³/₁₆" Corded Drawn Gliderpole System - Single Cord

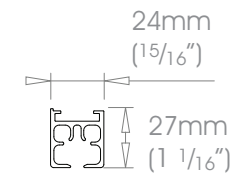
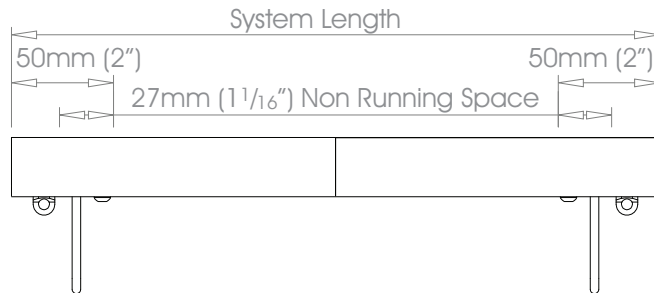

-  Gliders Single stack → up to 3m (10')
- Pair stack → ← up to 6m (20')
-  Rollers Single stack → up to 6m (20')
- Pair stack → ← up to 6m (20')

-  Wave - Gliders Single stack → up to 3m (10')
- Pair stack → ← up to 6m (20')
-  Wave - Rollers Single stack → up to 6m (20')
- Pair stack → ← up to 6m (20')



Round 30mm (1³/₁₆" Corded Drawn Gliderpole System - Twin Cord

-  Gliders Pair stack → ← up to 6m (20')
-  Rollers Pair stack → ← up to 6m (20')

-  Wave - Gliders Pair stack → ← up to 6m (20')
-  Wave - Rollers Pair stack → ← up to 6m (20')

GLIDERPOLE® Corded • Round Ø30mm (1 3/16")

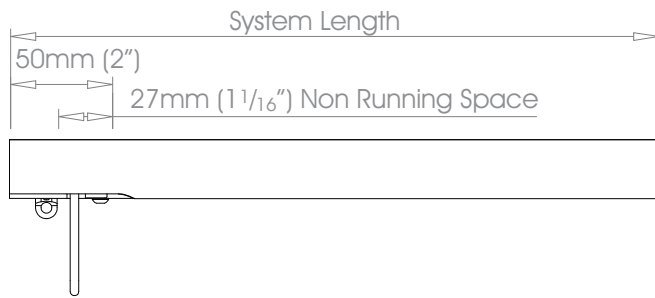

Finishes

Alabaster • Dusk • Granite • Slate • Flint • Barley • Dove • Millstone • Clay • Cocoa • Cloud • Ceramic • Bone • Cream • Parchment • Damson • Moss • Smoke • Frame Grey • Raven Coat Options: Matte (M) • Satin (S) • Gloss (G) • Platinum • Champagne • Gold • Cognac • Gunmetal • Antique Brass • Pewter • Bronzed Coat Options: Satin (S) • Gloss (G)
 Natural Silver • Bright Aluminium
Custom Finishes Can be specified subject to a per colour upcharge, (up to five poles)





Round 30mm (1 3/16") Corded Drawn Gliderpole System - Single Cord

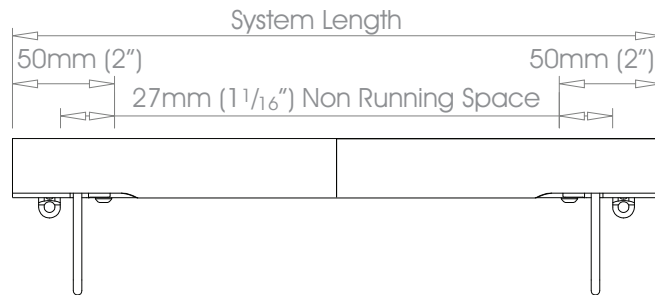

-  Gliders Single stack → up to 3m (10')
- Pair stack → ← up to 6m (20')
-  Rollers Single stack → up to 6m (20')
- Pair stack → ← up to 6m (20')

-  Wave - Gliders Single stack → up to 3m (10')
- Pair stack → ← up to 6m (20')
-  Wave - Rollers Single stack → up to 6m (20')
- Pair stack → ← up to 6m (20')



Round 30mm (1 3/16") Corded Drawn Gliderpole System - Twin Cord

-  Gliders Pair stack → ← up to 6m (20')
-  Rollers Pair stack → ← up to 6m (20')

-  Wave - Gliders Pair stack → ← up to 6m (20')
-  Wave - Rollers Pair stack → ← up to 6m (20')

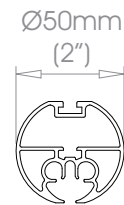
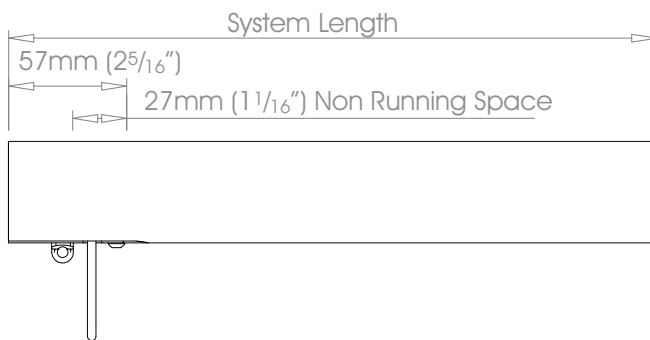

GLIDERPOLE® Corded • Round Ø50mm (2")

Finishes Alabaster • Dusk • Granite • Slate • Flint • Barley • Dove • Millstone • Clay • Cocoa • Cloud • Ceramic • Bone • Cream • Parchment • Damson • Moss • Smoke • Frame Grey • Raven Coat Options: Matte (M) • Satin (S) • Gloss (G) Platinum • Champagne • Gold • Cognac • Gunmetal • Antique Brass • Pewter • Bronzed Coat Options: Satin (S) • Gloss (G)
 Natural Silver
Custom Finishes Can be specified subject to a per colour upcharge, (up to five poles)





Round 50mm (2") Corded Drawn Gliderpole System - Single Cord*

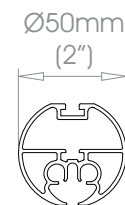
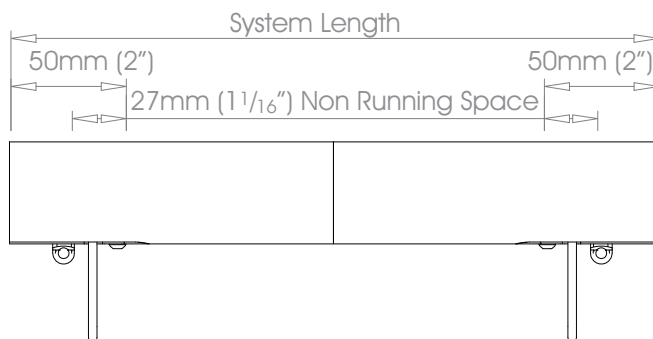

-  Gliders Single stack → up to 3m (10')
- Pair stack → ← up to 6m (20')
-  Rollers Single stack → up to 6m (20')
- Pair stack → ← up to 6m (20')

-  Wave - Gliders Single stack → up to 3m (10')
- Pair stack → ← up to 6m (20')
-  Wave - Rollers Single stack → up to 6m (20')
- Pair stack → ← up to 6m (20')



Round 50mm (2") Corded Drawn Gliderpole System - Twin Cord*

-  Gliders Pair stack → ← up to 6m (20')
-  Rollers Pair stack → ← up to 6m (20')

-  Wave - Gliders Pair stack → ← up to 6m (20')
-  Wave - Rollers Pair stack → ← up to 6m (20')

* 50mm (2") Gliderpole not available in bright aluminium finish

GLIDERPOLE® Corded • Bay Bends

Finishes Alabaster • Dusk • Granite • Slate • Flint • Barley • Dove • Millstone • Clay • Cocoa • Cloud • Ceramic • Bone • Cream • Parchment • Damson • Moss • Smoke • Frame Grey • Raven Coat Options: Matte (M) • Satin (S) • Gloss (G) • Platinum • Champagne • Gold • Cognac • Gunmetal • Antique Brass • Pewter • Bronzed Coat Options: Satin (S) • Gloss (G)
Natural Silver • Bright Aluminium (Not available on Square or 50mm (2") gliderpole)
Custom Finishes Can be specified subject to a per colour upcharge, (up to five poles)

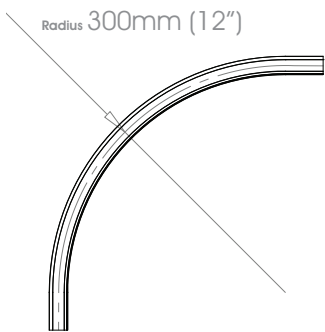

Radius 300mm (12")
Square 37mm (1 1/16") Bay Bend

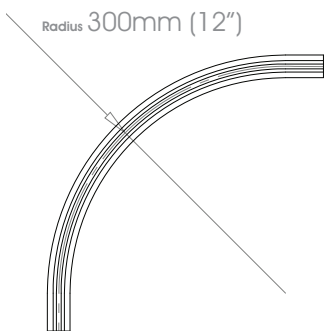

Radius 300mm (12")
Round 30mm (1 3/16") Bay Bend

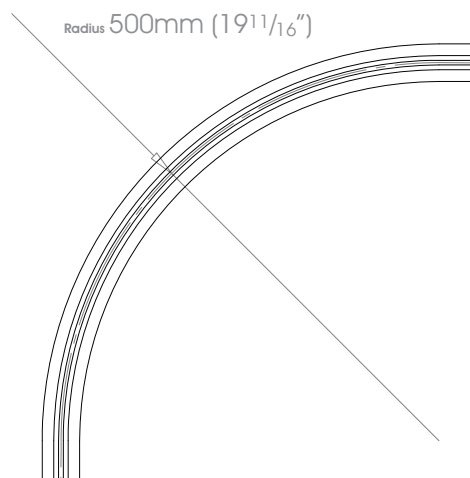

Radius 500mm (19 1/16")
Round 50mm (2") Bay Bend*

* Square & 50mm (2") Gliderpole not available in Bright Aluminium finish

GLIDERPOLE® Corded • Continuous Curves

Finishes Alabaster • Dusk • Granite • Slate • Flint • Barley • Dove • Millstone • Clay • Cocoa • Cloud • Ceramic • Bone • Cream • Parchment • Damson • Moss • Smoke • Frame Grey • Raven Coat Options: Matte (M) • Satin (S) • Gloss (G) • Platinum • Champagne • Gold • Cognac • Gunmetal • Antique Brass • Pewter • Bronzed Coat Options: Satin (S) • Gloss (G)
Natural Silver • Bright Aluminium (Not available on Square or 50mm (2") gliderpole)
Custom Finishes Can be specified subject to a per colour upcharge, (up to five poles)

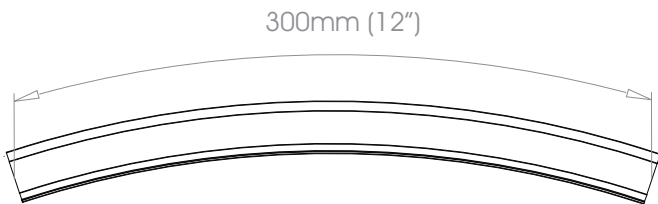

Square 37mm (1 1/16") Continuous Curve - 300mm (1ft)

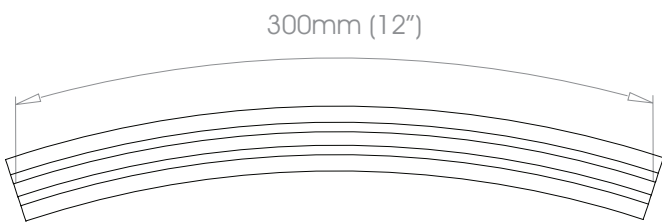

Round 30mm (1 3/16") Continuous Curve - 300mm (1ft)

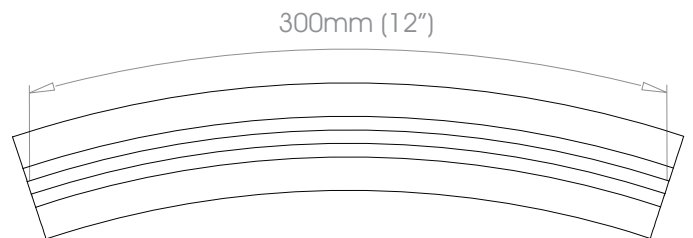

Round 50mm (2") Continuous Curve - 300mm (1ft)*

* Square & 50mm (2") Gliderpole not available in Bright Aluminium finish