

# STEEL Rings • Classic Ring

**Finishes** Polished • Natural Steel • Brass Toned • Matte Brass Toned • Bronzed (SATIN) • Oil Rubbed • Waxed • Flint (SATIN)  
**Custom Finishes** Can be specified subject to a per colour upcharge. (up to five poles)

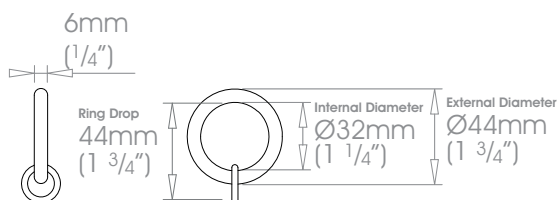

19mm (3/4") Classic Ring

 Weight 30g (1oz)

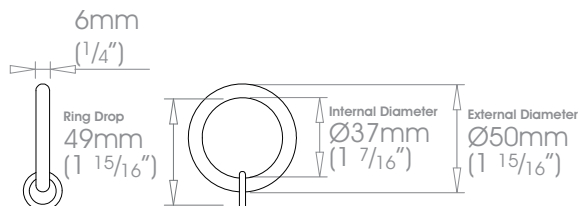

25mm (1") Classic Ring

 Weight 38g (1oz)

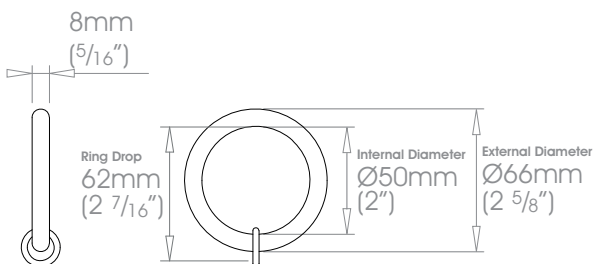

38mm (1 1/2") Classic Ring

 Weight 76g (3oz)

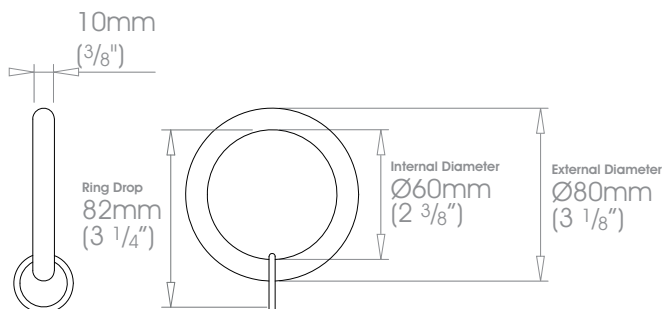

50mm (2") Classic Ring

 Weight 138g (5oz)