

GLIDE

THE **BRADLEY** COLLECTION

SPECIFICATION GUIDE

SPECIFICATION GUIDE

This specification guide was designed to outline the main considerations that need to be made when quoting or ordering a system.

If any questions arise please call your local sales representative or contact The Bradley Collection directly.

System Information Page 3-17

POLES Page 4

JOINTING SYSTEM Page 5

BAYS & MINIMUM WALL SIZES Page 6

BRACKET ALIGNMENT Page 7

CUSTOM BRACKETS Page 8

CURTAIN DROPS Page 9-11

POLE CONFIGURATION Page 12

CURTAIN STACKS Page 13

GLIDING OPTIONS & CURTAIN HEADINGS Page 14-15

CURTAIN WEIGHTS Page 16

MAXIMUM WEIGHTS Page 17

Finishes Page 18-22

Finials Page 23-33

Poles Page 34-39

Brackets Page 40-51

Accessories Page 52-53

Poles are cut, bent and curved to suit individual requirements. When calculating the length of your pole, remember to allow tolerance beyond the width of the frame for the curtains to stack back to the edge of the window.

Poles exceeding the maximum length will be cut into equal parts unless otherwise specified. Jointing system will be supplied. (See page 5) Brackets should be placed at every join.

Ø30mm (1 3/16") • 38mm (1 1/2")

The overall pole cost is rounded up in 300mm (1ft) increments.

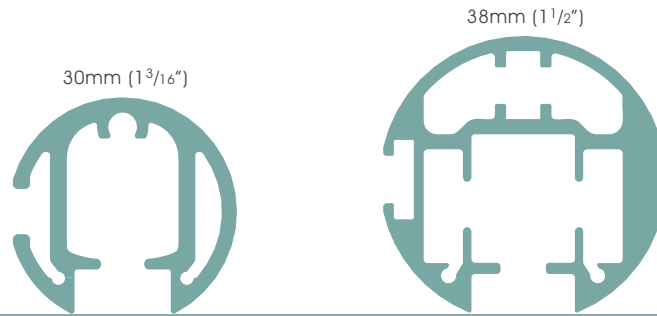

Size	Maximum distance between brackets	Maximum length in one piece	Standard Bend radius
Ø30mm (1 3/16")	1000mm (39")	4000mm (157")Ⓢ	R250mm (10")
Ø38mm (1 1/2")	1000mm (39")	4000mm (157")Ⓢ	R400mm (16")

Ⓢ Supplied in sections - Section lengths over 3.0m (118") will incur a handling charge
For full technical information, sizes and weights please download the specification guide - www.bradleycollection.com/downloads/

PROVIDING POLE LENGTHS

Pole lengths can be specified in two ways.

OPTION A is our preferred method. This covers Pole length only. **OPTION B** combines pole and finial lengths.

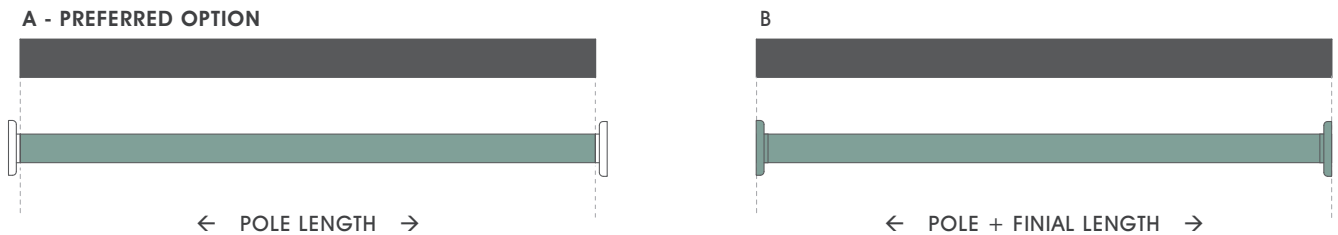

GLIDE

JOINTING SYSTEM

Glide's jointing system ensures perfect alignment between pole sections.

Joints must always be supported by a bracket.

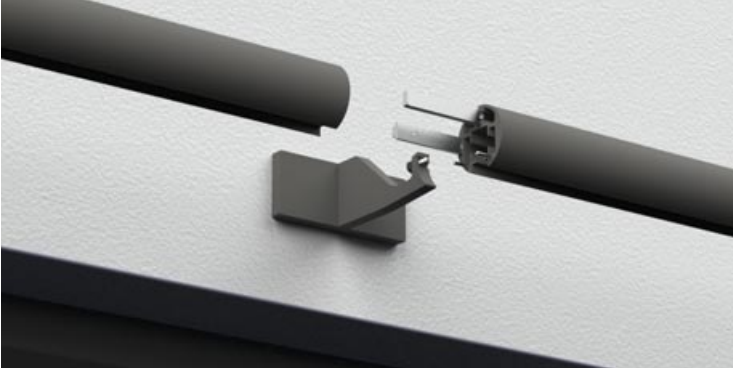

30mm (1 3/16")

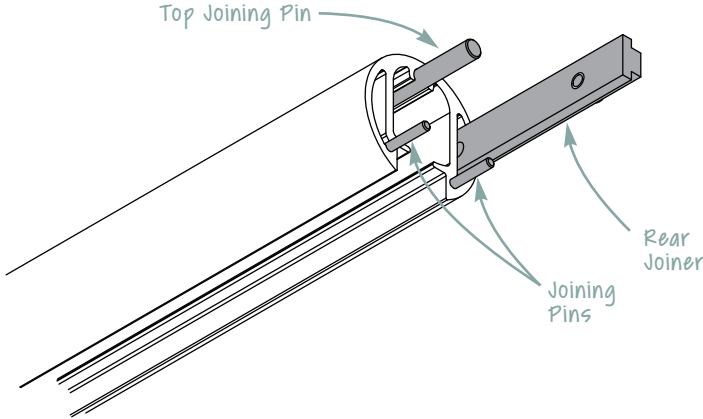

38mm (1 1/2")

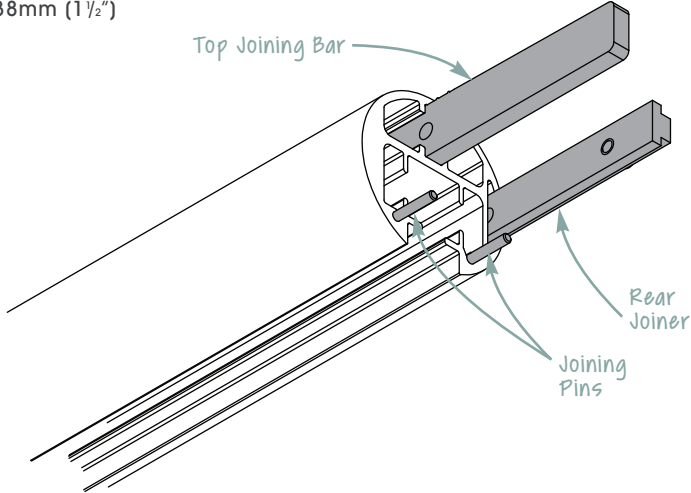

Bradley's bespoke service allows poles to be specifically made for unique bay windows and complex long span installations. Poles can be shaped to create a system that follows contours.

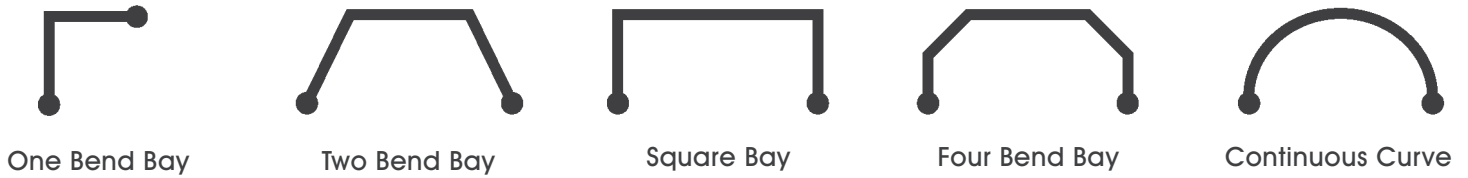

! Return bends are not available.

MINIMUM WALL SIZES

The table below is a guide for the minimum wall size required to fit a bend into the space.

Standard bend radius shown is the minimum radius achievable

Note: changes in angles and projections will alter the minimum wall sizes required

135° Bend Angles

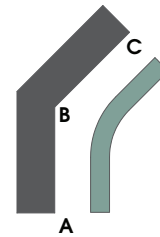

90° Bend Angles

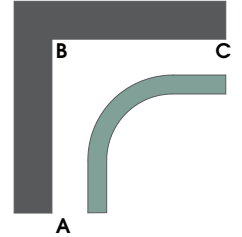

Diameter	Wall A - B	Wall B - C	Angle at B	Standard Bend Radius	Projection
∅30mm (1 ³ / ₁₆ "	241mm (9 ¹ / ₂ "	315mm (12 ⁷ / ₁₆ "	135°	250mm (10"	60mm (2 ³ / ₈ "
∅30mm (1 ³ / ₁₆ "	475mm (18 ¹¹ / ₁₆ "	550mm (22 ⁵ / ₈ "	90°	250mm (10"	60mm (2 ³ / ₈ "
∅38mm (1 ¹ / ₂ "	282mm (11 ¹ / ₈ "	367mm (14 ⁷ / ₁₆ "	135°	400mm (16"	100mm (4"
∅38mm (1 ¹ / ₂ "	575mm (22 ⁵ / ₈ "	660mm (26"	90°	400mm (16"	100mm (4"

BRADLEY BAY CHECKER +

Bay Checker + is part of our Digital Toolbox, allowing you to check your measurement for bays and curves whilst onsite, as well as storing straight window dimensions for your projects.

Unlimited measurements may be saved locally to your device or shared to your colleagues.

Available as a free download for iOS or Android,

For more information on Bay Checker + and latest enhancements to our Digital Toolbox visit

www.bradleycollection.com/digital-toolbox/

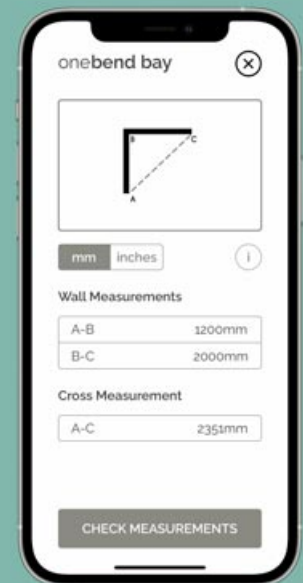

The information below shows the relationship between the bracket backplate. this will enable easy alignments during installation.

SINGLE SYSTEM - $\varnothing 30\text{mm}$ ($1\frac{3}{16}$ "

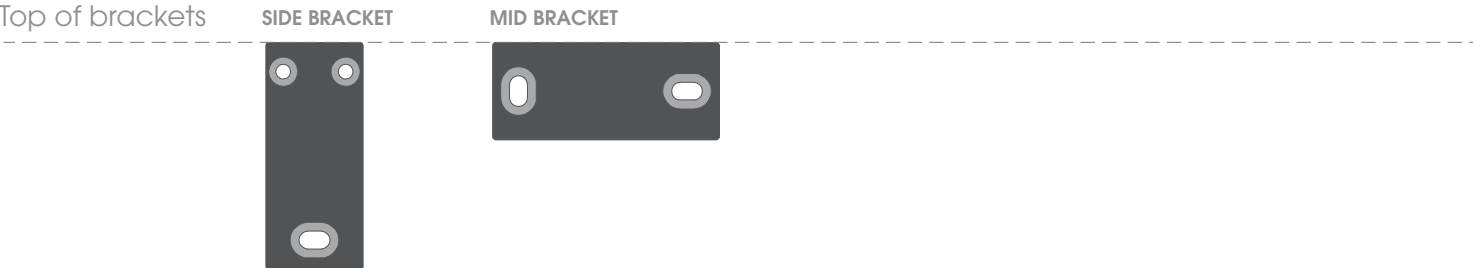

SINGLE SYSTEM - $\varnothing 38\text{mm}$ ($1\frac{1}{2}$ "

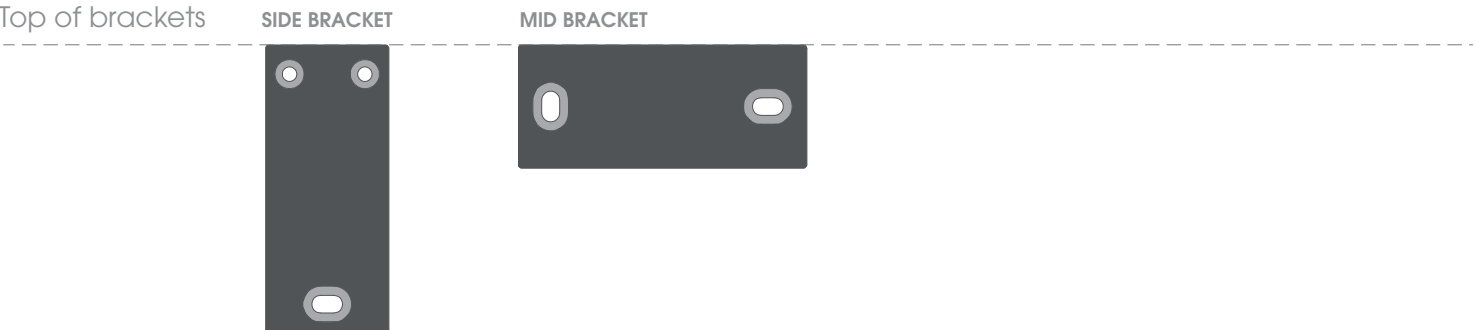

DOUBLE SYSTEMS

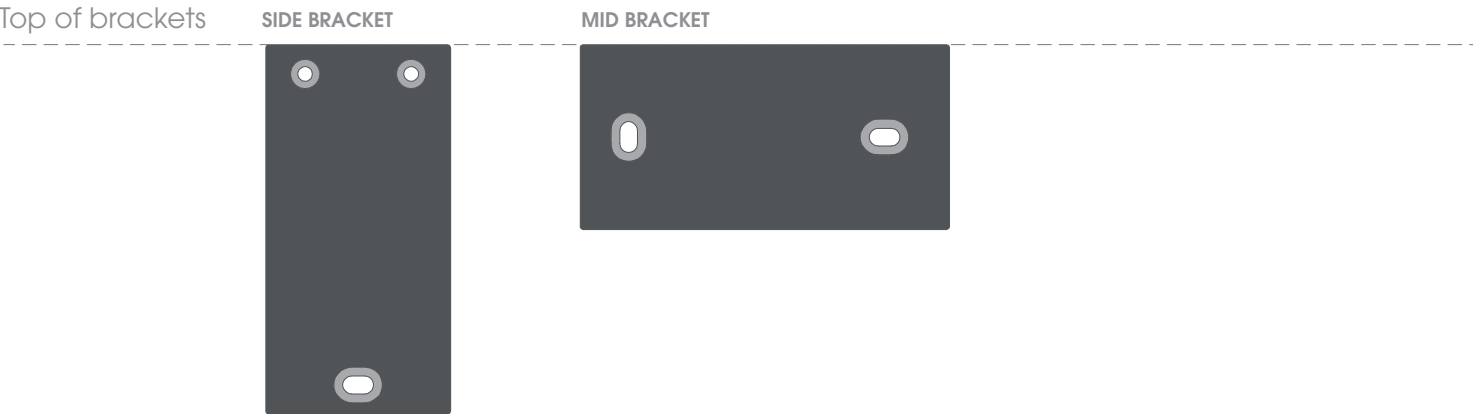

Glide can be customised to suit virtually any window. For simple projection changes between the Minimums and Maximums listed below brackets are charged at double their standard cost. For all other customisations an additional up-charge and custom fee is applied per drawing,



Custom Projection

Specify the exact projection needed.



Custom Fixing Plate

Relevant where space is restricted or weight is a concern.



Uplift

Helps negotiate cornice and similar architectural features.



Ceiling Brackets

Specify exact projection required from ceiling.



Angled Brackets

The solution for tight and awkward locations.

MINIMUM & MAXIMUM BRACKET PROJECTIONS

Dimensions outside of these stated min/max projections may still be possible but will generate a design charge per drawing. See pricelist for details

Diameter	Type	Standard Projection(s)	Minimum Projection	Maximum Projection
∅30mm (1 ³ / ₁₆ "	Side	60mm (2 ³ / ₈ " • 100mm (4")	70mm (2 ³ / ₄ "	200mm (8")
∅30mm (1 ³ / ₁₆ "	Mid	60mm (2 ³ / ₈ " • 100mm (4")	70mm (2 ³ / ₄ "	200mm (8")
∅38mm (1 ¹ / ₂ "	Side	100mm (4")	83mm (3 ¹ / ₄ "	200mm (8")
∅38mm (1 ¹ / ₂ "	Mid	100mm (4")	83mm (3 ¹ / ₄ "	200mm (8")

The information below shows the relationship between the pole, brackets and gliders/rollers. This will enable the correlation between pole heights and curtain drops to be easily calculated.

SINGLE SYSTEM - $\varnothing 30\text{mm}$ ($1\frac{3}{16}$ "

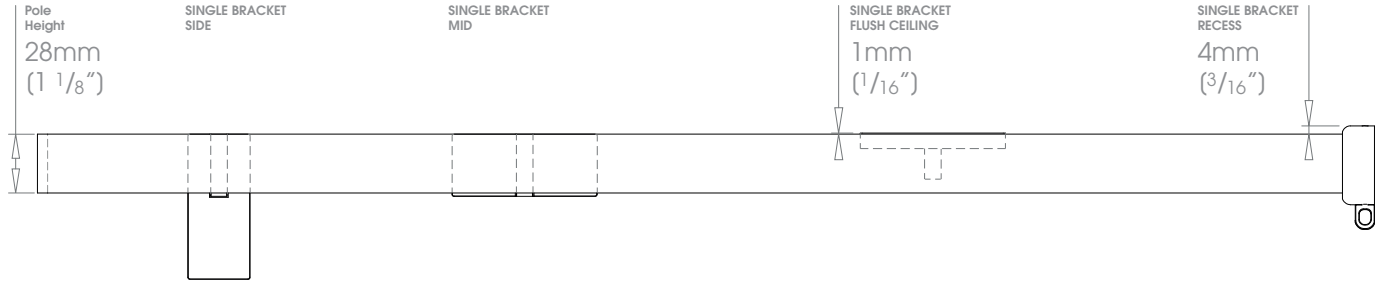

DOUBLE SYSTEM - FRONT $\varnothing 30\text{mm}$ ($1\frac{3}{16}$ "

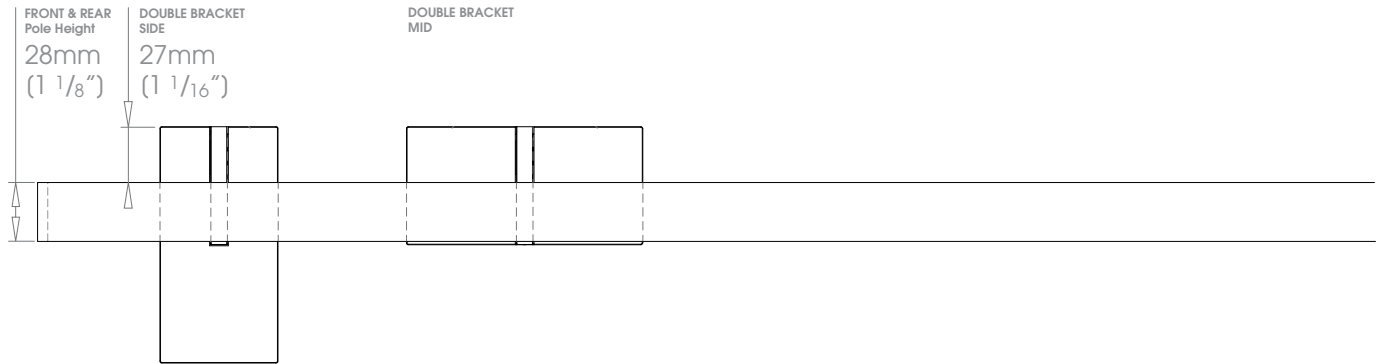

PIN HOOK MEASUREMENT

From bottom of the track

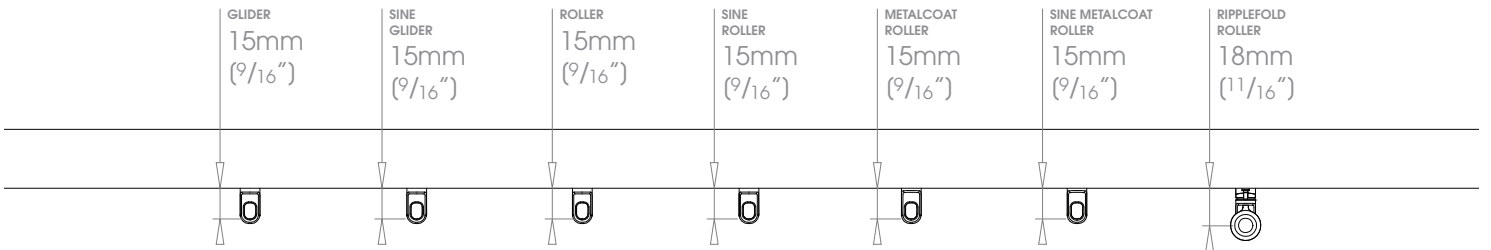

The information below shows the relationship between the pole, brackets and gliders/rollers. This will enable the correlation between pole heights and curtain drops to be easily calculated.

SINGLE SYSTEM - $\varnothing 38\text{mm}$ ($1\frac{1}{2}$ "

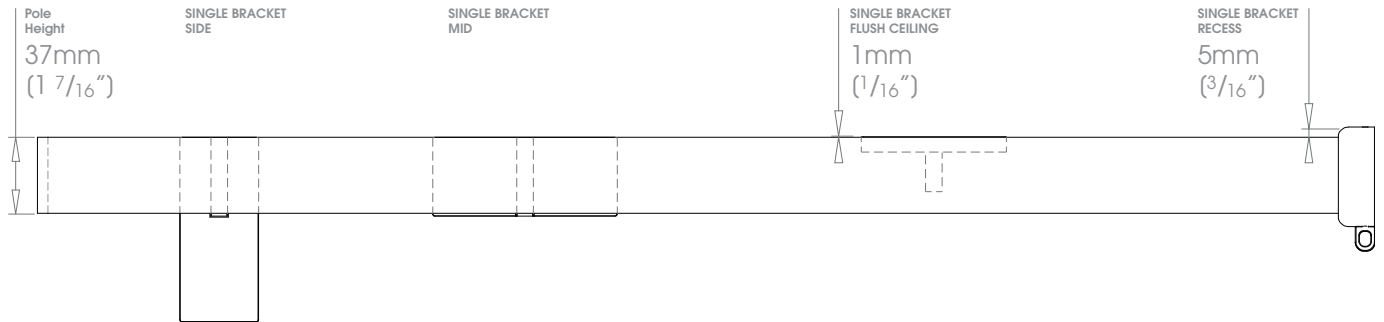

DOUBLE SYSTEM - FRONT $\varnothing 38\text{mm}$ ($1\frac{1}{2}$ " BACK $\varnothing 30\text{mm}$ ($1\frac{3}{16}$ "

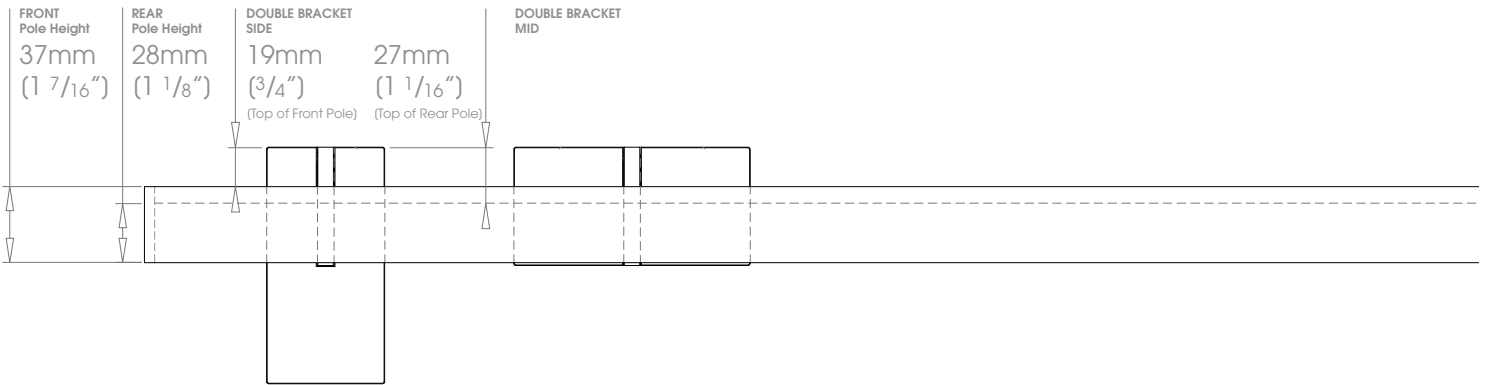

DOUBLE SYSTEM - FRONT $\varnothing 38\text{mm}$ ($1\frac{1}{2}$ " BACK $\varnothing 38\text{mm}$ ($1\frac{1}{2}$ "

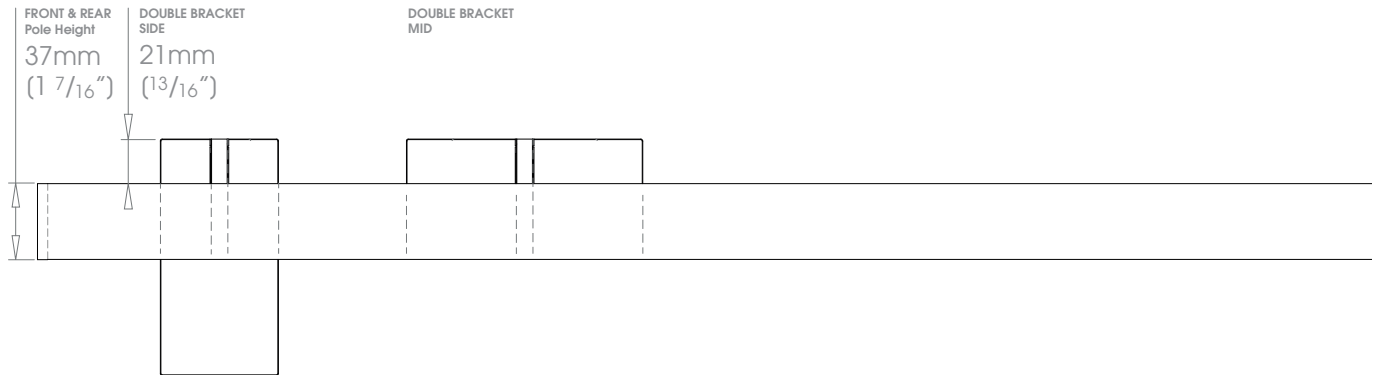

PIN HOOK MEASUREMENT

From bottom of the track

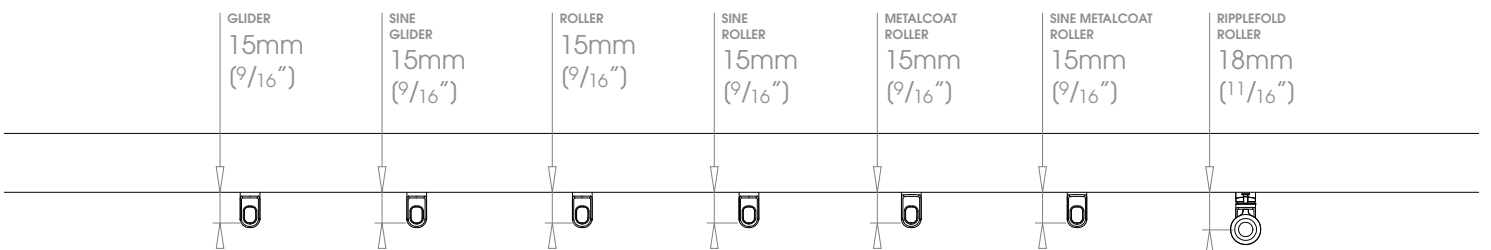

The information below shows the relationship between the pole, brackets and gliders/rollers.
This will enable the correlation between pole heights and curtain drops to be easily calculated.



Partition Brackets can not be used around bay windows

DOUBLE PARTITION SYSTEM - FRONT $\varnothing 30\text{mm}$ ($1\frac{3}{16}$ ") BACK $\varnothing 30\text{mm}$ ($1\frac{3}{16}$ ")

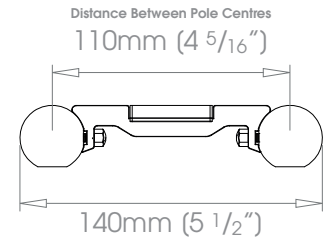
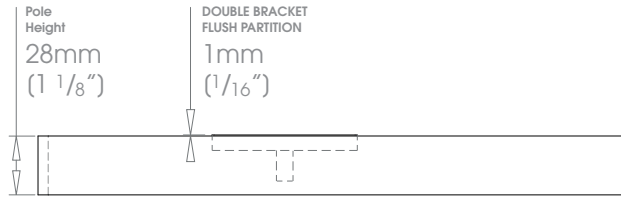

DOUBLE PARTITION SYSTEM - FRONT $\varnothing 38\text{mm}$ ($1\frac{1}{2}$ ") BACK $\varnothing 38\text{mm}$ ($1\frac{1}{2}$ ")

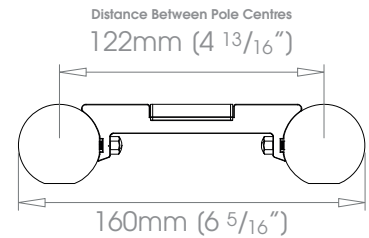
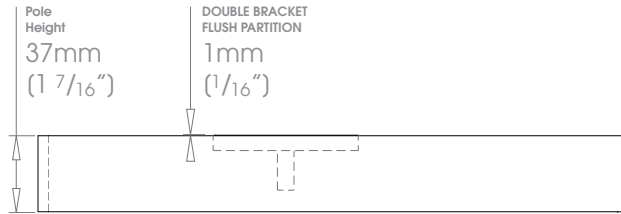

PIN HOOK MEASUREMENT

From bottom of the track

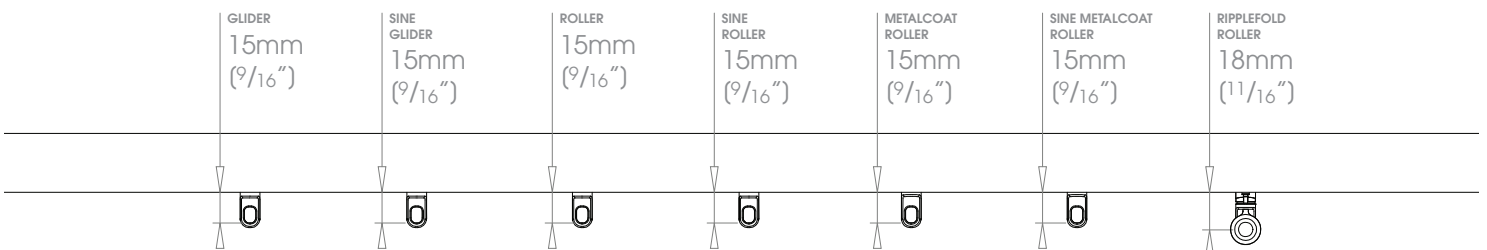

GLIDE

POLE CONFIGURATION

Systems will be supplied as per the diagrams below.

GLIDER ACCESS

For single stack curtains a glider access point will be positioned the same side as the curtain stack.

For pair stack curtains the access point will be positioned on the right hand side, unless otherwise requested.

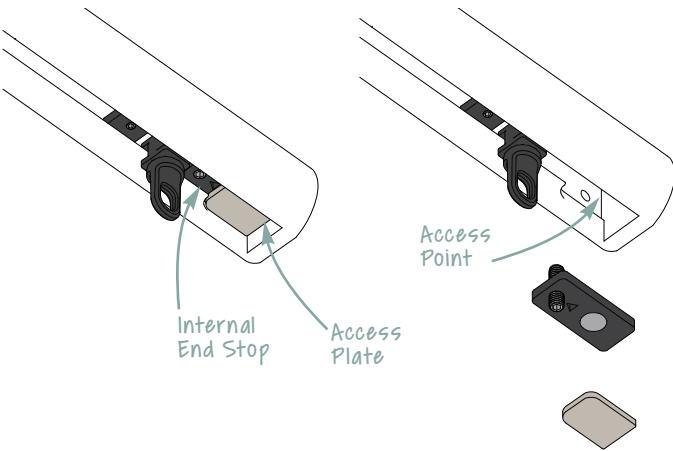

T-BAR ACCESS

For poles made in one piece, a T-Bar access point will positioned on the righthand side

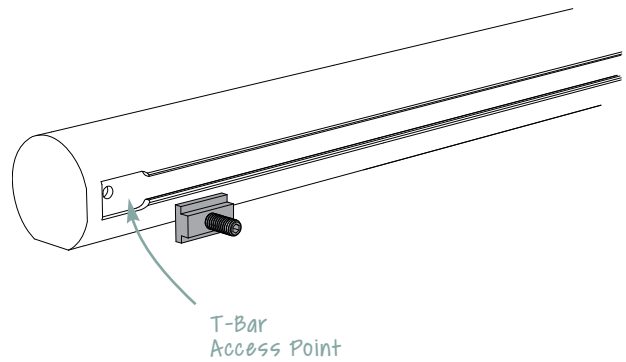

GLIDE POLE SYSTEMS

*Gliders • Rollers • Metalcoat Rollers
Sine Gliders • Sine Rollers • Metalcoat Sine Rollers
Metalcoat Ripplefold Rollers*

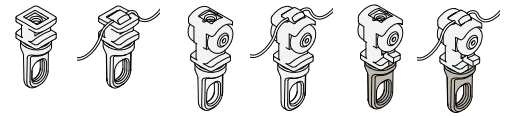

SINGLE STACK ▶

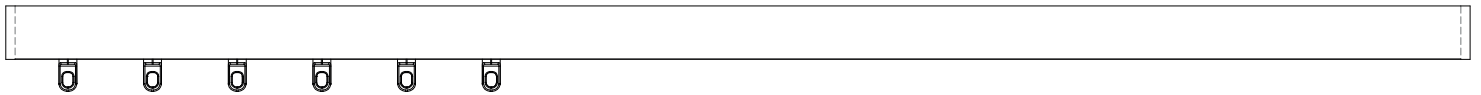

SUPPLIED WITH

1x Internal End Stop • 1x Glider Access Plate (Access will be positioned the same side as curtain stack)

PAIR STACK ▶◀

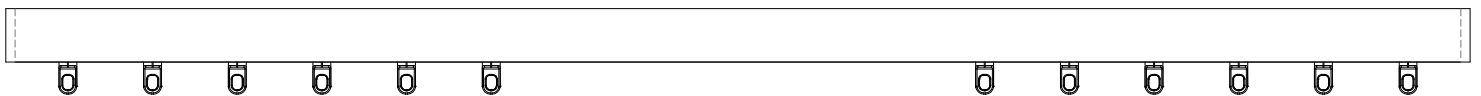

SUPPLIED WITH

2x Internal End Stop • 1x Glider Access Plate (Access will be positioned as standard on the right hand side)

STACK SIZES

This is the area where the curtains hang against the wall when they are pulled open. by covering the wall and not the glass, during the day, it allows more light into the room. Allow approximately 30% of the length of the track for curtain stacking, very full curtains (e.g. pencil pleat) will need more space than flatter ones. lined and interlined curtains will also require more stacking space than unlined.

Single Stack ▶



Pair Stack ▶◀



STANDARD HEADINGS



GLIDERS

Gliders are suitable for most installations. one glider is specified for every 100mm (4").
Glider Colour Options: Gypsum • Anthracite

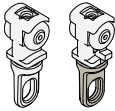

ROLLERS • METALCOAT ROLLERS

Rollers are preferred for heavy drapery & Systems with joins one roller is specified for every 100mm (4").
Roller Colour Options: Gypsum • Anthracite
Metalcoat Colour Options: System Colour ©

STANDARD
Fullness 1.5

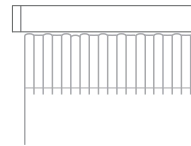

PINCH PLEAT
Fullness 2.0



PENCIL PLEAT
Fullness 2.5 (Heavy)
Fullness 2.5 (Voiles)

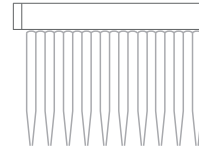

Pencil pleats will have a larger stack back and performance may be reduced

SINE HEADINGS

Sine headings are a simple S folded heading system consisting of rollers spaced by a cord and a special pocketed header tape that is sewn onto a flat panel curtain. it offers an elegant, contemporary look.

- Ideal for both residential and commercial settings.
- Drapery is constructed special pocketed header tape that is sewn onto a flat panel curtain
- Hooks are fitted to header tape at a set spacing shown below creating the ripple effect
- Fullness can be adjusted by changing the hook spacing.

SINE • RIPPLE
Fullness 2.3

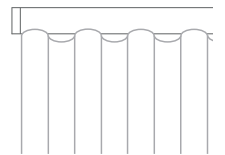

FABRIC SUITABILITY

There is no standard test that will indicate whether a fabric is suitable for wave style. However, experience suggests it is normally suitable for:

✓ Voiles • Lined cotton • Interlined Silk • Blackout lining

The soft curves of Wave do not lend themselves to:

✗ Stiff fabrics • Heavy embroidery • Irregular vertical stripes • Metallic threads



SINE GLIDERS

Gliders are suitable for most installations.
Sine Pitch: 80mm (3 1/8")
Sine Glider Colour Options: Gypsum - White Cord • Anthracite - White Cord

Glider-Cord Spacing	Curtain Hook Spacing	Approx. Curtain Fullness	Stack Depth per 1M (39 3/8") of pole	Min Bracket Projection
80mm (3 1/8")	160mm (6 3/16")	2.3	180mm (7 1/16")	100mm (4")

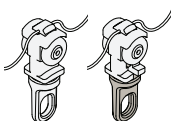

SINE ROLLERS • METALCOAT SINE ROLLERS

Rollers are preferred for heavy drapery.
Sine Pitch: 60mm (2 3/8") • 80mm (3 1/8")
Sine Roller Colour Options: Gypsum - White Cord • Anthracite - Black Cord
Metalcoat Sine Roller Colour Options: System Colour ©

Roller-Cord Spacing	Curtain Hook Spacing	Approx. Curtain Fullness	Stack Depth per 1M (39 3/8") of pole	Min Bracket Projection
60mm (2 3/16")	120mm (4 3/4")	2.3	230mm (9 1/16")	100mm (4")
80mm (3 1/8")	160mm (6 3/16")	2.3	180mm (7 1/16")	100mm (4")

RIPPLEFOLD HEADING

Ripplefold pleat style is named for the soft, consistent ripples created by the drapery as it hangs from the track. It offers an elegant, contemporary look.

- Ideal for both residential and commercial settings.
- Drapery is constructed with snap tape (graber® is required) that allows the drapery to be snapped directly to the auxiliary carriers on the track.
- Fullness of the drapery is determined by the spacing of the carriers in the track. the higher the fullness factor, the more full the draperies appear.
- 3 fullness factors are available

RIPPLEFOLD

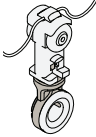
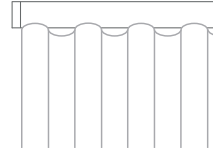

RIPPLEFOLD ROLLERS

Rollers are preferred for heavy drapery.

Ripplefold® Fullness: 80% • 100%

Metalcoat Ripplefold® Roller Colour Options: System Colour ☺

	Roller-Cord Spacing	Curtain Fullness	Stack Depth per 1M (39 7/8") of pole	Min Bracket Projection
	60mm (2 3/8")	80%	270mm (10 5/8")	100mm (4")
	55mm (2 1/16")	100%	310mm (12 3/16")	100mm (4")

Different types of fabric have widely differing weights. The type of curtain heading used (see below) will determine the fullness of the fabric used: this can be anything from 1.5 x the width of the pole to 3.0 x pole width.

The chart below assumes 100% fullness (2.0 x width of the pole) the weights are very approx and can vary for many reasons. Always check the expected and final total curtain weight with the curtain maker. Based on 1200mm (48") fabric width

Curtain Type	Width⇄/Drop⇅	1m (3.5')	2m (7')	3m (10.5')	4m (14")	5m (16.5')	6m (20")
Print Cotton (Light)	1m (3.5')	0.8kg (1.8lb)	1.7kg (3.7lb)	2.5kg (5.5lb)	3.4kg (7.4lb)	4.2kg (9.2lb)	5.0kg (11.1lb)
	2m (7')	1.3kg (2.8lb)	2.5g (5.5lb)	3.8kg (8.3lb)	5kg (11.1lb)	6.3kg (13.9lb)	7.6kg (16.6lb)
	3m (10')	1.7kg (3.7lb)	3.4kg (7.4lb)	5kg (11.1lb)	6.7kg (14.8lb)	8.4kg (18.5lb)	10kg (22lb)
Linen (Medium)	1m (3.5')	1.1kg (2.3lb)	2.1kg (4.6lb)	3.2kg (6.9lb)	4.2kg (9.2lb)	5.3kg (11.6lb)	6.3kg (13.9lb)
	2m (7')	1.6kg (3.5lb)	3.2kg (6.9lb)	4.7kg (10.4lb)	6.3kg (13.9lb)	7.9kg (17.3lb)	9.5kg (20.8lb)
	3m (10')	2.1kg (4.6lb)	4.2kg (9.2lb)	6.3kg (13.9lb)	8.4kg (18.5lb)	10.5kg (23.1lb)	12.6kg (27.7lb)
Velvet (Heavy)	1m (3.5')	1.5kg (3.2lb)	3.2kg (6.5lb)	4.4kg (9.7lb)	5.9kg (12.9lb)	7.4kg (16.2lb)	8.8kg (19.4lb)
	2m (7')	2.2kg (4.9lb)	4.4kg (9.7lb)	6.7kg (12.6lb)	8.8kg (19.4lb)	11kg (24.3lb)	13.2kg (22lb)
	3m (10')	2.9kg (6.5lb)	5.9kg (12.9lb)	8.8kg (19.4lb)	11.8kg (26lb)	14.7kg (32.2lb)	17.6kg (39lb)

Maximum weight recommendations for all standard curtain types using gliders & roller are defined to ensure safe and proper function of the system. These must be adhered to. See table below for details of all options.



Bends will considerably reduce the load bearing capability of any system.

GLIDERS • SINE GLIDERS

Gliders One glider is specified for every 100mm (4").

Sine Gliders 80mm (3 1/8") spacing between the gliders.

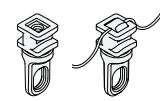

System Width	Straight	Straight	1 Bend Bay	1 Bend Bay	2 Bend Bay	2 Bend Bay	Curved	Curved
	Single Stack ▶	Pair Stack ▶◀	Single Stack ▶	Pair Stack ▶◀	Single Stack ▶	Pair Stack ▶◀	Single Stack ▶	Pair Stack ▶◀
1m (39 3/8")	9kg (19.8lb)	10kg (22lb)	7kg (15.4lb)	8kg (17.6lb)	4kg (8.8lb)	5kg (11lb)	3kg (6.6lb)	4kg (8.8lb)
2m (78 3/8")	9kg (19.8lb)	10kg (22lb)	7kg (15.4lb)	8kg (17.6lb)	4kg (8.8lb)	5kg (11lb)	3kg (6.6lb)	4kg (8.8lb)
3m (118 1/8")	8kg (17.6lb)	9kg (19.8lb)	6kg (12.2lb)	7kg (15.4lb)	3kg (6.6lb)	4kg (8.8lb)	2kg (4.4lb)	3kg (6.6lb)
4m (157 1/2")	8kg (17.6lb)	9kg (19.8lb)	6kg (12.2lb)	7kg (15.4lb)	3kg (6.6lb)	4kg (8.8lb)	2kg (4.4lb)	3kg (6.6lb)
5m (196 7/8")	7kg (15.4lb)	8kg (17.6lb)	5kg (11lb)	6kg (12.2lb)	2kg (4.4lb)	3kg (6.6lb)	1kg (2.2lb)	2kg (4.4lb)
6m (236 1/4")	7kg (15.4lb)	8kg (17.6lb)	5kg (11lb)	6kg (12.2lb)	2kg (4.4lb)	3kg (6.6lb)	1kg (2.2lb)	2kg (4.4lb)

ROLLERS • SINE ROLLERS

METALCOAT ROLLERS • METALCOAT SINE ROLLERS • METALCOAT RIPPLEFOLD ROLLERS

Rollers One roller is specified for every 100mm (4").

Sine Rollers 60mm (2 3/8") • 80mm (3 1/8") spacing between the rollers.

Ripplefold Rollers Fullness options 80% • 100%

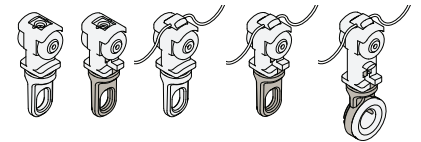

System Width	Straight	Straight	1 Bend Bay	1 Bend Bay	2 Bend Bay	2 Bend Bay	Curved	Curved
	Single Stack ▶	Pair Stack ▶◀	Single Stack ▶	Pair Stack ▶◀	Single Stack ▶	Pair Stack ▶◀	Single Stack ▶	Pair Stack ▶◀
1m (39 3/8")	12kg (26.5lb)	13kg (28.7lb)	9kg (19.8lb)	10kg (22lb)	6kg (12.2lb)	7kg (15.4lb)	5kg (11lb)	6kg (12.2lb)
2m (78 3/8")	11kg (24.3lb)	13kg (28.7lb)	8kg (17.6lb)	9kg (19.8lb)	5kg (11lb)	6kg (12.2lb)	4kg (8.8lb)	5kg (11lb)
3m (118 1/8")	11kg (24.3lb)	12kg (26.5lb)	8kg (17.6lb)	9kg (19.8lb)	5kg (11lb)	6kg (12.2lb)	4kg (8.8lb)	5kg (11lb)
4m (157 1/2")	11kg (24.3lb)	11kg (24.3lb)	8kg (17.6lb)	9kg (19.8lb)	5kg (11lb)	6kg (12.2lb)	4kg (8.8lb)	5kg (11lb)
5m (196 7/8")	10kg (22lb)	11kg (24.3lb)	7kg (15.4lb)	8kg (17.6lb)	4kg (8.8lb)	5kg (11lb)	3kg (6.6lb)	4kg (8.8lb)
6m (236 1/4")	10kg (22lb)	10kg (22lb)	7kg (15.4lb)	8kg (17.6lb)	4kg (8.8lb)	5kg (11lb)	3kg (6.6lb)	4kg (8.8lb)

All poles and components may be specified in this stunning palette of colours and finishes, with a choice of coat options throughout.

SHADES

A superb selection of opaque colours, all available in a choice of Matte, Satin or Gloss finish.

COAT OPTIONS

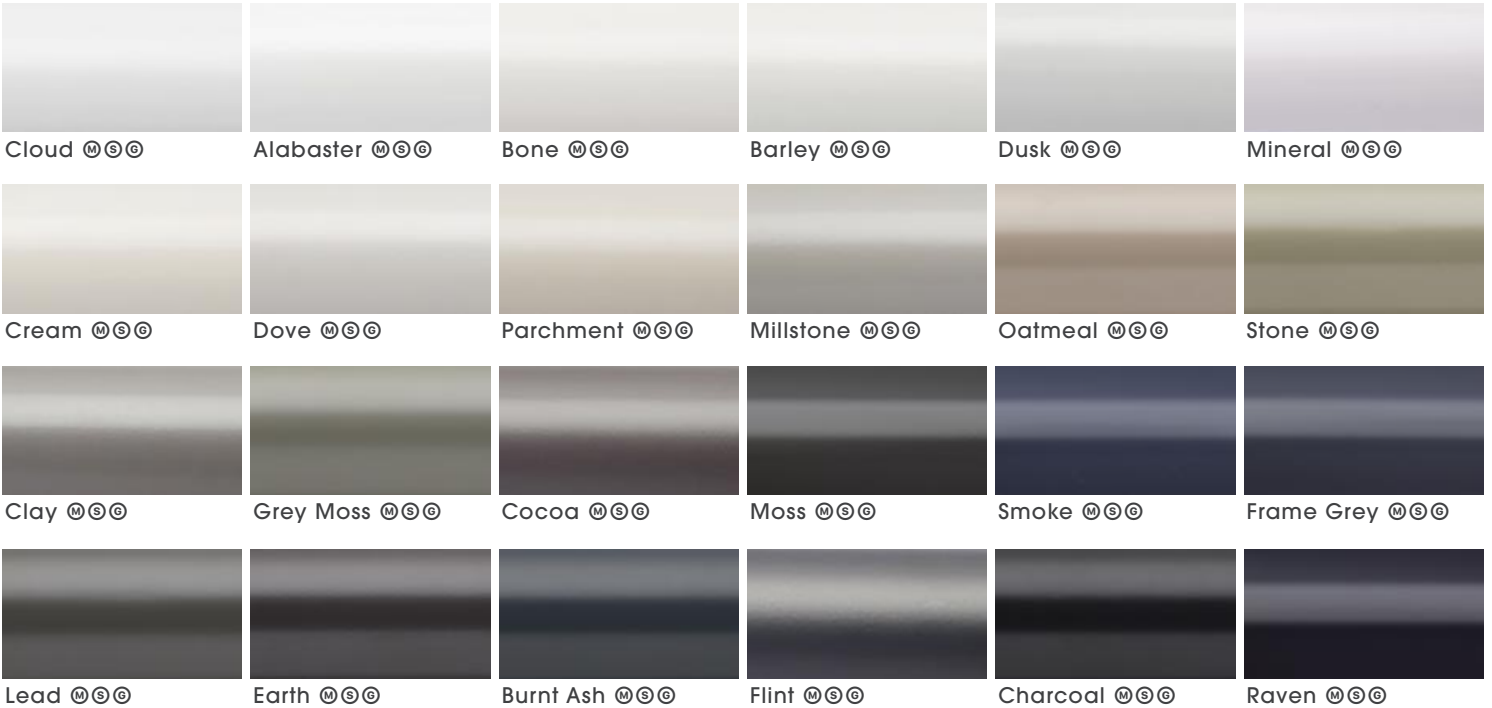

METALLICS

High metallic fleck coatings with all available in Satin and Gloss sheen levels.

COAT OPTIONS

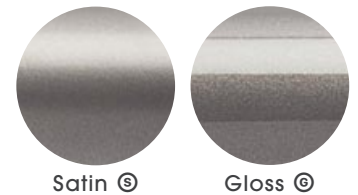

ANODICS

A flat metal colour group, with an anodised style surface texture.

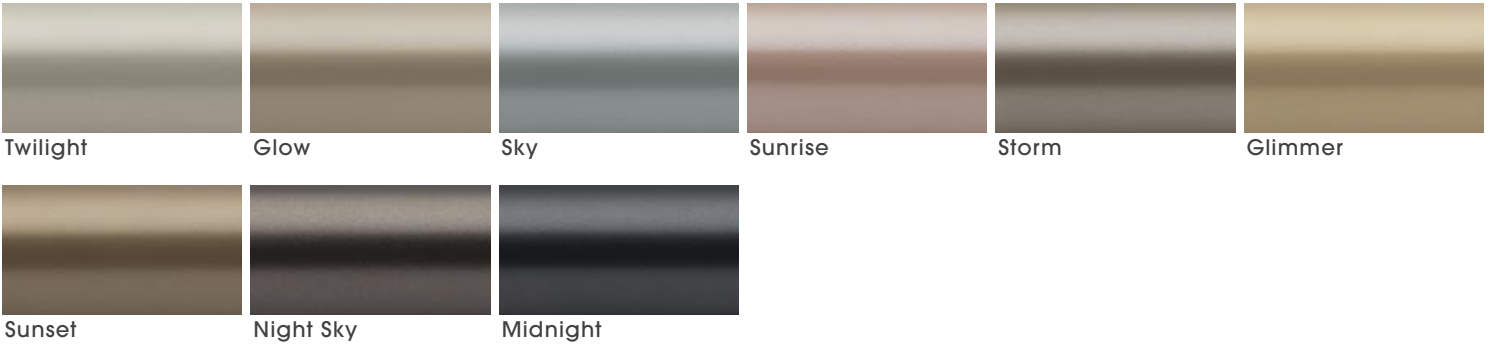

ORGANICS

A textured finish, inspired by nature.



CERAMICS

Finished with ceramic Cerakote for industry leading protection and a flawless finish that endures daily life.

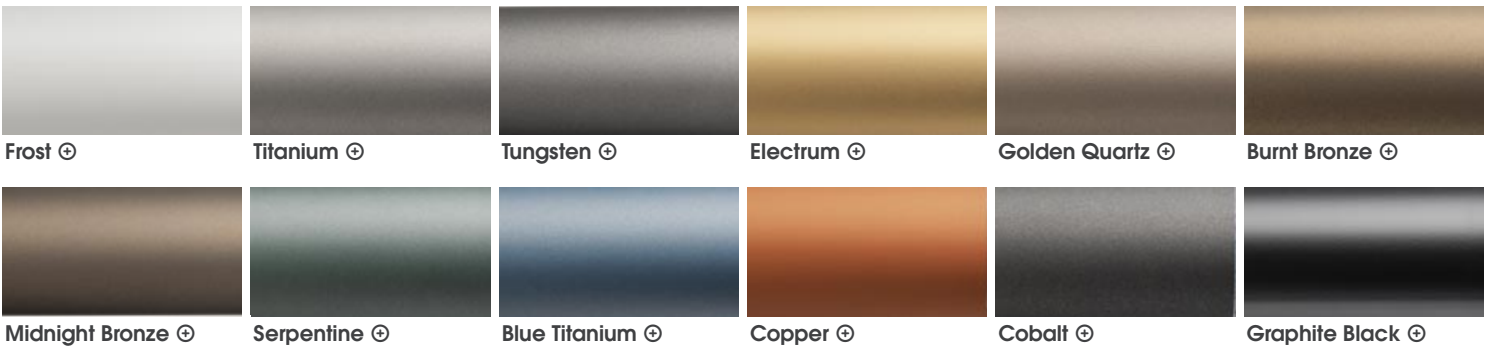

CHROMATICS

Brushed and etched aluminium, elevated with modern tints. Understated luxury with an architectural edge. Sealed in a clear, ceramic coating for lasting durability.

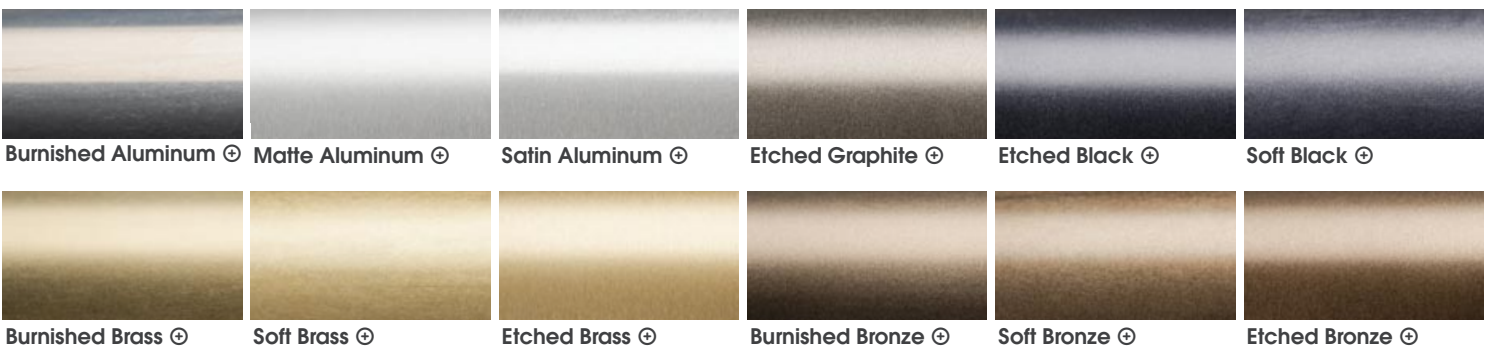

CUSTOM FINISHES

Can be specified from RAL K7 finish chart, subject to a per colour upcharge.
Which covers up to five poles. See price list for further details..



COLOUR MATCHING

A colour matching service is offered, to match your scheme of fittings perfectly . See price list for further details

Metalcoat Rollers will be supplied with bodies in either Gypsum or Anthracite bodies to compliment the chosen finish. See table below

Coat Options Matte[Ⓜ] • Satin[Ⓢ] • Gloss[ⓖ]

SHADES • METALLICS • ANODICS • ORGANICS

System Finish	Gypsum  	Anthracite  
Alabaster ^{ⓂⓈⓖ}	✓	
Antique Brass ^{ⓂⓈ}		✓
Ashstone		✓
Barley ^{ⓂⓈⓖ}	✓	
Bone ^{ⓂⓈⓖ}	✓	
Burnt Ash ^{ⓂⓈⓖ}		✓
Bronzed ^{ⓂⓈ}		✓
Champagne ^{ⓂⓈ}		✓
Charcoal ^{ⓂⓈⓖ}		✓
Clay ^{ⓂⓈⓖ}		✓
Cloud ^{ⓂⓈⓖ}	✓	
Cocoa ^{ⓂⓈⓖ}		✓
Cognac ^{ⓂⓈ}		✓
Cream ^{ⓂⓈⓖ}	✓	
Dove ^{ⓂⓈⓖ}	✓	
Dusk ^{ⓂⓈⓖ}	✓	
Earth ^{ⓂⓈⓖ}		✓
Flint ^{ⓂⓈⓖ}		✓
Frame Grey ^{ⓂⓈⓖ}		✓
Glimmer		✓
Glow		✓
Gold ^{ⓂⓈ}		✓
Grey Moss ^{ⓂⓈⓖ}		✓
Gunmetal ^{ⓂⓈ}		✓
Iron		✓
Lead ^{ⓂⓈⓖ}		✓
Midnight		✓
Millstone ^{ⓂⓈⓖ}		✓
Mineral ^{ⓂⓈⓖ}	✓	
Moss ^{ⓂⓈⓖ}		✓
Night Sky		✓
Oatmeal ^{ⓂⓈⓖ}		✓
Obsidian		✓
Parchment ^{ⓂⓈⓖ}	✓	
Pewter ^{ⓂⓈ}		✓
Platinum ^{ⓂⓈ}		✓
Raven ^{ⓂⓈⓖ}		✓
Sand Stone		✓
Sky		✓
Smoke ^{ⓂⓈⓖ}		✓
Stone ^{ⓂⓈⓖ}		✓
Storm		✓
Sunrise		✓
Sunset		✓
Twilight		✓

CERAMICS

System Finish	Gypsum  	Anthracite  
Blue Titanium		✓
Burnt Bronze		✓
Cobalt		✓
Copper		✓
Electrum		✓
Frost	✓	
Golden Quartz		✓
Graphite Black		✓
Midnight Bronze		✓
Serpentine		✓
Titanium		✓
Tungsten		✓

CHROMATICS

System Finish	Gypsum  	Anthracite  
Burnished Aluminium		✓
Burnished Brass		✓
Burnished Bronze		✓
Etched Black		✓
Etched Brass		✓
Etched Bronze		✓
Etched Graphite		✓
Matte Aluminium		✓
Satin Aluminium		✓
Soft Black		✓
Soft Brass		✓
Soft Bronze		✓



The seamless finial is an integral part of the pole.

If this is selected optional finial details cannot be added at a later date.

FINISHES

Coat Options

- Matte Ⓜ
- Satin Ⓢ
- Gloss Ⓤ

Metallics ⓂⓈ

Anodics ⓂⓈ

Organics

Ceramics

Chromatics

Alabaster • Barley • Bone • Burnt Ash • Charcoal • Clay • Cloud • Cocoa • Cream • Dove • Dusk • Earth • Flint • Frame Grey • Grey Moss
Lead • Millstone • Mineral • Moss • Oatmeal • Parchment • Raven • Smoke • Stone

Antique Brass • Bronzed • Champagne • Cognac • Gold • Gunmetal • Pewter • Platinum

Glimmer • Glow • Midnight • Night Sky • Sky • Storm • Sunrise • Sunset • Twilight

Ash Stone • Iron • Obsidian • Sand Stone

Available at +50% the cost of the standard finish | Blue Titanium • Burnt Bronze • Cobalt • Copper • Electrum • Frost • Golden Quartz

Graphite Black • Midnight Bronze • Serpentine • Titanium • Tungsten

Available at +50% the cost of the standard finish | Burnished Aluminum • Etched Aluminum • Matte Aluminum

Etched Graphite • Etched Black • Soft Black | Burnished Brass • Etched Brass • Soft Brass | Burnished Bronze • Etched Bronze • Soft Bronze

ø30mm (1 3/16")

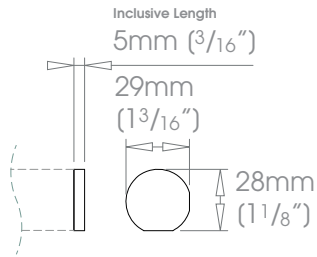

ø38mm (1 1/2")

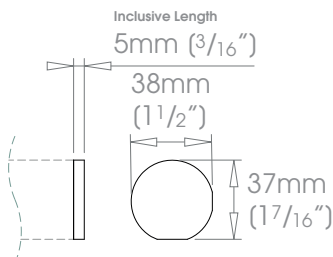



! Can only be added at point of order
 Finial detail cannot be used with Flush Ceiling Brackets / Flush Partition Brackets

- FINISHES** Shades ③③③ Alabaster • Barley • Bone • Burnt Ash • Charcoal • Clay • Cloud • Cocoa • Cream • Dove • Dusk • Earth • Flint • Frame Grey • Grey Moss
 Lead • Millstone • Mineral • Moss • Oatmeal • Parchment • Raven • Smoke • Stone
- Coat Options
 Matte ④
 Satin ⑤
 Gloss ⑥
- Metallics** ③②
 Antique Brass • Bronzed • Champagne • Cognac • Gold • Gunmetal • Pewter • Platinum
- Anodics**
 Glimmer • Glow • Midnight • Night Sky • Sky • Storm • Sunrise • Sunset • Twilight
- Organics**
 Ash Stone • Iron • Obsidian • Sand Stone
- Ceramics**
 Available at +50% the cost of the standard finish | Blue Titanium • Burnt Bronze • Cobalt • Copper • Electrum • Frost • Golden Quartz
 Graphite Black • Midnight Bronze • Serpentine • Titanium • Tungsten
- Chromatics**
 Available at +50% the cost of the standard finish | Burnished Aluminum • Etched Aluminum • Matte Aluminum
 Etched Graphite • Etched Black • Soft Black | Burnished Brass • Etched Brass • Soft Brass | Burnished Bronze • Etched Bronze • Soft Bronze

ø30mm (1 3/16")

ø38mm (1 1/2")

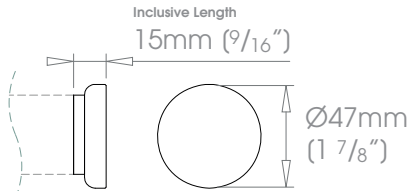
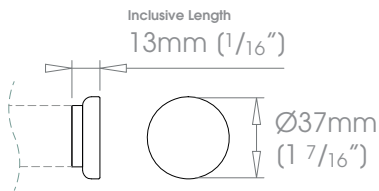



! Can only be added at point of order
 Finial detail cannot be used with Flush Ceiling Brackets / Flush Partition Brackets

FINISHES	Shades ☉☉☉	Alabaster • Barley • Bone • Burnt Ash • Charcoal • Clay • Cloud • Cocoa • Cream • Dove • Dusk • Earth • Flint • Frame Grey • Grey Moss • Lead • Millstone • Mineral • Moss • Oatmeal • Parchment • Raven • Smoke • Stone
	Coat Options	
	Metallics ☉☉	Antique Brass • Bronzed • Champagne • Cognac • Gold • Gunmetal • Pewter • Platinum
	Anodics ☉☉	Glimmer • Glow • Midnight • Night Sky • Sky • Storm • Sunrise • Sunset • Twilight
	Organics	Ash Stone • Iron • Obsidian • Sand Stone
	Ceramics	<i>Available at +50% the cost of the standard finish</i> Blue Titanium • Burnt Bronze • Cobalt • Copper • Electrum • Frost • Golden Quartz • Graphite Black • Midnight Bronze • Serpentine • Titanium • Tungsten
	Chromatics	<i>Available at +50% the cost of the standard finish</i> Burnished Aluminum • Etched Aluminum • Matte Aluminum • Etched Graphite • Etched Black • Soft Black Burnished Brass • Etched Brass • Soft Brass Burnished Bronze • Etched Bronze • Soft Bronze

ø30mm (1 3/16")

ø38mm (1 1/2")

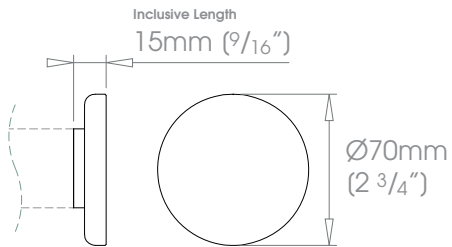
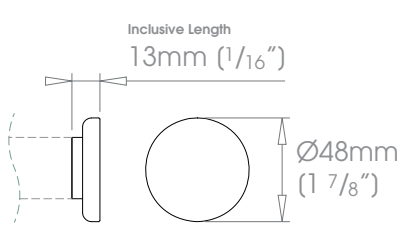



! Can only be added at point of order

- FINISHES**
- Shades** ☉☉☉ Alabaster • Barley • Bone • Burnt Ash • Charcoal • Clay • Cloud • Cocoa • Cream • Dove • Dusk • Earth • Flint • Frame Grey • Grey Moss • Lead • Millstone • Mineral • Moss • Oatmeal • Parchment • Raven • Smoke • Stone
 - Coat Options**
 - Matte** ☉
 - Satin** ☉
 - Gloss** ☉
 - Metallics** ☉☉ Antique Brass • Bronzed • Champagne • Cognac • Gold • Gunmetal • Pewter • Platinum
 - Anodics** ☉☉ Glimmer • Glow • Midnight • Night Sky • Sky • Storm • Sunrise • Sunset • Twilight
 - Organics** Ash Stone • Iron • Obsidian • Sand Stone
 - Ceramics** Available at +50% the cost of the standard finish | Blue Titanium • Burnt Bronze • Cobalt • Copper • Electrum • Frost • Golden Quartz • Graphite Black • Midnight Bronze • Serpentine • Titanium • Tungsten
 - Chromatics** Available at +50% the cost of the standard finish | Burnished Aluminum • Etched Aluminum • Matte Aluminum • Etched Graphite • Etched Black • Soft Black | Burnished Brass • Etched Brass • Soft Brass | Burnished Bronze • Etched Bronze • Soft Bronze

ø30mm (1 3/16")

ø38mm (1 1/2")

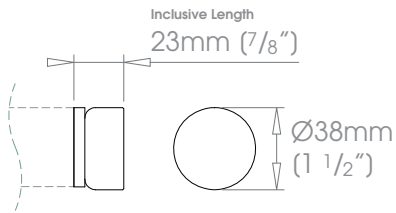
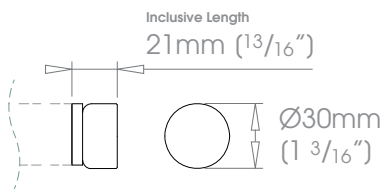



 Can only be added at point of order

- FINISHES**
- Shades**    Alabaster • Barley • Bone • Burnt Ash • Charcoal • Clay • Cloud • Cocoa • Cream • Dove • Dusk • Earth • Flint • Frame Grey • Grey Moss • Lead • Millstone • Mineral • Moss • Oatmeal • Parchment • Raven • Smoke • Stone
 - Coat Options**
 - Matte** 
 - Satin** 
 - Gloss** 
 - Metallics**   Antique Brass • Bronzed • Champagne • Cognac • Gold • Gunmetal • Pewter • Platinum
 - Anodics**  Glimmer • Glow • Midnight • Night Sky • Sky • Storm • Sunrise • Sunset • Twilight
 - Organics** Ash Stone • Iron • Obsidian • Sand Stone
 - Ceramics** *Available at +50% the cost of the standard finish* | Blue Titanium • Burnt Bronze • Cobalt • Copper • Electrum • Frost • Golden Quartz • Graphite Black • Midnight Bronze • Serpentine • Titanium • Tungsten
 - Chromatics** *Available at +50% the cost of the standard finish* | Burnished Aluminum • Etched Aluminum • Matte Aluminum • Etched Graphite • Etched Black • Soft Black | Burnished Brass • Etched Brass • Soft Brass | Burnished Bronze • Etched Bronze • Soft Bronze

ø30mm (1 3/16")

ø38mm (1 1/2")

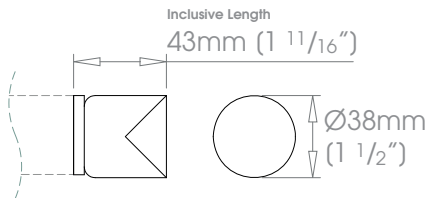
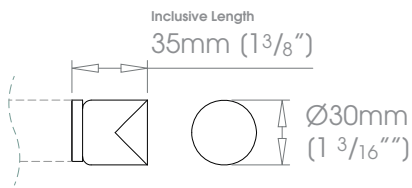



! Can only be added at point of order
 Finial detail cannot be used with Flush Ceiling Brackets / Flush Partition Brackets

- FINISHES**
- Shades** ☉☉☉ Alabaster • Barley • Bone • Burnt Ash • Charcoal • Clay • Cloud • Cocoa • Cream • Dove • Dusk • Earth • Flint • Frame Grey • Grey Moss • Lead • Millstone • Mineral • Moss • Oatmeal • Parchment • Raven • Smoke • Stone
 - Coat Options**
 - Matte** ☉
 - Satin** ☉
 - Gloss** ☉
 - Metallics** ☉☉ Antique Brass • Bronzed • Champagne • Cognac • Gold • Gunmetal • Pewter • Platinum
 - Anodics** ☉☉ Glimmer • Glow • Midnight • Night Sky • Sky • Storm • Sunrise • Sunset • Twilight
 - Organics** Ash Stone • Iron • Obsidian • Sand Stone
 - Ceramics** Available at +50% the cost of the standard finish | Blue Titanium • Burnt Bronze • Cobalt • Copper • Electrum • Frost • Golden Quartz • Graphite Black • Midnight Bronze • Serpentine • Titanium • Tungsten
 - Chromatics** Available at +50% the cost of the standard finish | Burnished Aluminum • Etched Aluminum • Matte Aluminum • Etched Graphite • Etched Black • Soft Black | Burnished Brass • Etched Brass • Soft Brass | Burnished Bronze • Etched Bronze • Soft Bronze

ø30mm (1 3/16")

ø38mm (1 1/2")

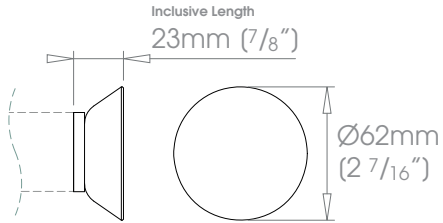
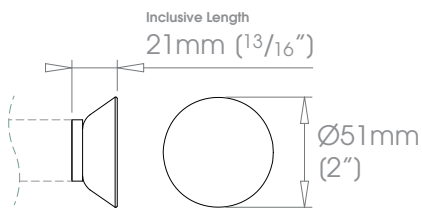



! Can only be added at point of order
 Finial detail cannot be used with Flush Ceiling Brackets / Flush Partition Brackets

- FINISHES**
- Shades** ☉☉☉ Alabaster • Barley • Bone • Burnt Ash • Charcoal • Clay • Cloud • Cocoa • Cream • Dove • Dusk • Earth • Flint • Frame Grey • Grey Moss • Lead • Millstone • Mineral • Moss • Oatmeal • Parchment • Raven • Smoke • Stone
 - Coat Options**
 - Matte** ☉
 - Satin** ☉
 - Gloss** ☉
 - Metallics** ☉☉ Antique Brass • Bronzed • Champagne • Cognac • Gold • Gunmetal • Pewter • Platinum
 - Anodics** ☉☉ Glimmer • Glow • Midnight • Night Sky • Sky • Storm • Sunrise • Sunset • Twilight
 - Organics** Ash Stone • Iron • Obsidian • Sand Stone
 - Ceramics** Available at +50% the cost of the standard finish | Blue Titanium • Burnt Bronze • Cobalt • Copper • Electrum • Frost • Golden Quartz • Graphite Black • Midnight Bronze • Serpentine • Titanium • Tungsten
 - Chromatics** Available at +50% the cost of the standard finish | Burnished Aluminum • Etched Aluminum • Matte Aluminum • Etched Graphite • Etched Black • Soft Black | Burnished Brass • Etched Brass • Soft Brass | Burnished Bronze • Etched Bronze • Soft Bronze

ø30mm (1 3/16")

ø38mm (1 1/2")

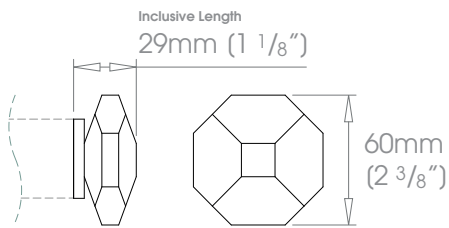
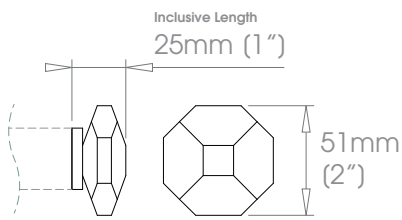



! Can only be added at point of order
 Finial detail cannot be used with Flush Ceiling Brackets / Flush Partition Brackets

- FINISHES**
- Shades** ☉☉☉ Alabaster • Barley • Bone • Burnt Ash • Charcoal • Clay • Cloud • Cocoa • Cream • Dove • Dusk • Earth • Flint • Frame Grey • Grey Moss • Lead • Millstone • Mineral • Moss • Oatmeal • Parchment • Raven • Smoke • Stone
 - Coat Options**
 - Matte** ☉
 - Satin** ☉
 - Gloss** ☉
 - Metallics** ☉☉ Antique Brass • Bronzed • Champagne • Cognac • Gold • Gunmetal • Pewter • Platinum
 - Anodics** ☉☉ Glimmer • Glow • Midnight • Night Sky • Sky • Storm • Sunrise • Sunset • Twilight
 - Organics** Ash Stone • Iron • Obsidian • Sand Stone
 - Ceramics** Available at +50% the cost of the standard finish | Blue Titanium • Burnt Bronze • Cobalt • Copper • Electrum • Frost • Golden Quartz • Graphite Black • Midnight Bronze • Serpentine • Titanium • Tungsten
 - Chromatics** Available at +50% the cost of the standard finish | Burnished Aluminum • Etched Aluminum • Matte Aluminum • Etched Graphite • Etched Black • Soft Black | Burnished Brass • Etched Brass • Soft Brass | Burnished Bronze • Etched Bronze • Soft Bronze

ø30mm (1 3/16")

ø38mm (1 1/2")

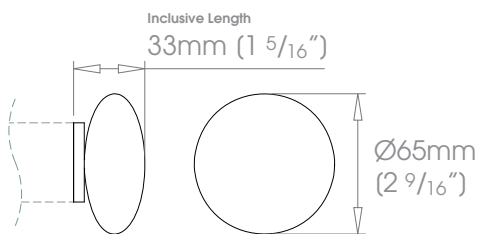
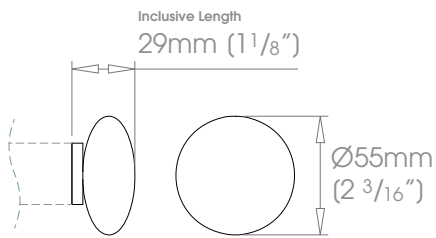



! Can only be added at point of order
 Finial detail cannot be used with Flush Ceiling Brackets / Flush Partition Brackets

- FINISHES** Shades ③③③ Alabaster • Barley • Bone • Burnt Ash • Charcoal • Clay • Cloud • Cocoa • Cream • Dove • Dusk • Earth • Flint • Frame Grey • Grey Moss
 Lead • Millstone • Mineral • Moss • Oatmeal • Parchment • Raven • Smoke • Stone
- Coat Options
 Matte ②
 Satin ③
 Gloss ④
- Metallics** ③②
 Antique Brass • Bronzed • Champagne • Cognac • Gold • Gunmetal • Pewter • Platinum
- Anodics**
 Glimmer • Glow • Midnight • Night Sky • Sky • Storm • Sunrise • Sunset • Twilight
- Organics**
 Ash Stone • Iron • Obsidian • Sand Stone
- Ceramics**
 Available at +50% the cost of the standard finish | Blue Titanium • Burnt Bronze • Cobalt • Copper • Electrum • Frost • Golden Quartz
 Graphite Black • Midnight Bronze • Serpentine • Titanium • Tungsten
- Chromatics**
 Available at +50% the cost of the standard finish | Burnished Aluminum • Etched Aluminum • Matte Aluminum
 Etched Graphite • Etched Black • Soft Black | Burnished Brass • Etched Brass • Soft Brass | Burnished Bronze • Etched Bronze • Soft Bronze

∅30mm (1 3/16")

∅38mm (1 1/2")

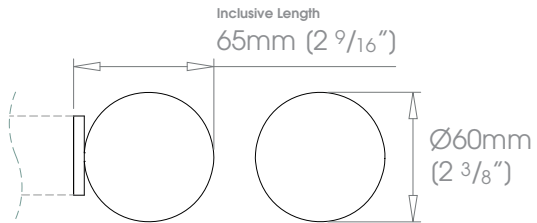
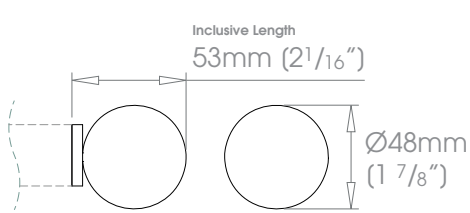

The following finials from our other collections can be specified on request.



Finials listed below cannot be used with Flush Ceiling Brackets / Flush Partition Brackets

MIO

For specific please refer to the Mio Specification Guide.

Final	Diameter(s)
Stud	∅38mm (1 1/2")
Disc	∅38mm (1 1/2")
Faceted Disc	∅38mm (1 1/2")
Pebble	∅38mm (1 1/2")
Squat Disc	∅38mm (1 1/2")
Ball	∅38mm (1 1/2")
Crystal Ball	∅38mm (1 1/2")

ELYSIAN

For specific please refer to the Elysian Specification Guide.

Final	Diameter(s)
Halo	∅30mm (1 3/16") • ∅38mm (1 1/2")
Aura	∅30mm (1 3/16") • ∅38mm (1 1/2")
Orbit	∅30mm (1 3/16") • ∅38mm (1 1/2")
Discus	∅30mm (1 3/16") • ∅38mm (1 1/2")
Jewel	∅30mm (1 3/16") • ∅38mm (1 1/2")
Flute	∅30mm (1 3/16") • ∅38mm (1 1/2")
Squat Globe	∅30mm (1 3/16") • ∅38mm (1 1/2")
Globe	∅30mm (1 3/16") • ∅38mm (1 1/2")
Ribbed Globe	∅30mm (1 3/16") • ∅38mm (1 1/2")
Charm	∅30mm (1 3/16") • ∅38mm (1 1/2")
Templar	∅30mm (1 3/16") • ∅38mm (1 1/2")
Crystal Templar	∅38mm (1 1/2")

GLIDE

POLES



FINISHES

Coat Options

- Matte
- Satin
- Gloss

Metallics

Anodics

Organics

Ceramics

Chromatics

Shades Alabaster • Barley • Bone • Burnt Ash • Charcoal • Clay • Cloud • Cocoa • Cream • Dove • Dusk • Earth • Flint • Frame Grey • Grey Moss
 Lead • Millstone • Mineral • Moss • Oatmeal • Parchment • Raven • Smoke • Stone
Metallics Antique Brass • Bronzed • Champagne • Cognac • Gold • Gunmetal • Pewter • Platinum
Anodics Glimmer • Glow • Midnight • Night Sky • Sky • Storm • Sunrise • Sunset • Twilight
Organics Ash Stone • Iron • Obsidian • Sand Stone
Ceramics Available at +50% the cost of the standard finish | Blue Titanium • Burnt Bronze • Cobalt • Copper • Electrum • Frost • Golden Quartz
 Graphite Black • Midnight Bronze • Serpentine • Titanium • Tungsten
Chromatics Available at +50% the cost of the standard finish | Burnished Aluminum • Etched Aluminum • Matte Aluminum
 Etched Graphite • Etched Black • Soft Black | Burnished Brass • Etched Brass • Soft Brass | Burnished Bronze • Etched Bronze • Soft Bronze

ø30mm (1 3/16")

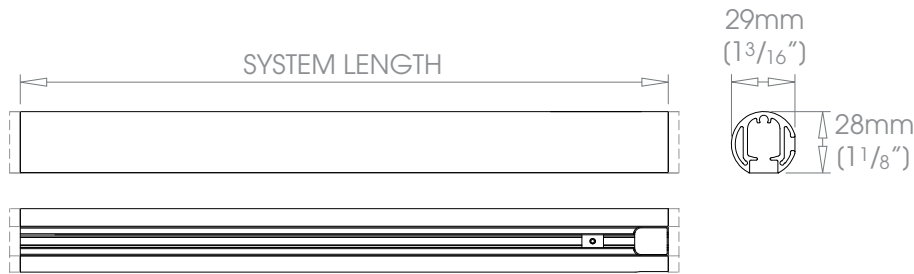

Glider Options

SINGLE STACK ► • PAIR STACK ►◄



GLIDER

Colour options:
Gypsum • Anthracite



SINE GLIDER

Colour options:
Gypsum • Anthracite

Sine Pitch:
80mm (3 1/8")

Roller Options

SINGLE STACK ► • PAIR STACK ►◄



ROLLER

Colour options:
Gypsum • Anthracite



SINE ROLLER

Colour options:
Gypsum • Anthracite

Sine Pitch:
60mm (2 3/8") • 80mm (3 1/8")



METALCOAT ROLLER

Colour options:
System Colour



METALCOAT SINE ROLLER

Colour options:
System Colour

Sine Pitch:
60mm (2 3/8") • 80mm (3 1/8")



METALCOAT RIPPLEFOLD ROLLER

Colour options:
System Colour

Fullness:
80% • 100%



FINISHES

Coat Options

- Matte
- Satin
- Gloss

Metallics

Anodics

Organics

Ceramics

Chromatics

- Shades** Alabaster • Barley • Bone • Burnt Ash • Charcoal • Clay • Cloud • Cocoa • Cream • Dove • Dusk • Earth • Flint • Frame Grey • Grey Moss
Lead • Millstone • Mineral • Moss • Oatmeal • Parchment • Raven • Smoke • Stone
- Metallics** Antique Brass • Bronzed • Champagne • Cognac • Gold • Gunmetal • Pewter • Platinum
Glimmer • Glow • Midnight • Night Sky • Sky • Storm • Sunrise • Sunset • Twilight
- Anodics** Ash Stone • Iron • Obsidian • Sand Stone
- Organics** Available at +50% the cost of the standard finish | Blue Titanium • Burnt Bronze • Cobalt • Copper • Electrum • Frost • Golden Quartz
Graphite Black • Midnight Bronze • Serpentine • Titanium • Tungsten
- Ceramics** Available at +50% the cost of the standard finish | Burnished Aluminum • Etched Aluminum • Matte Aluminum
Etched Graphite • Etched Black • Soft Black | Burnished Brass • Etched Brass • Soft Brass | Burnished Bronze • Etched Bronze • Soft Bronze

ø38mm (1 1/2")

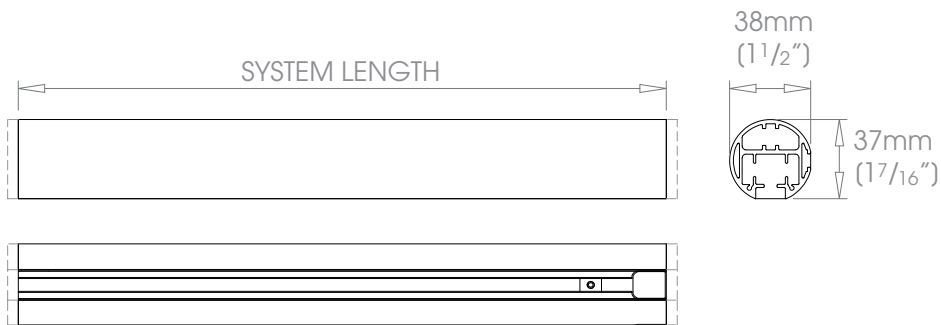

Glider Options

SINGLE STACK ► • PAIR STACK ►◄



GLIDER

Colour options:
Gypsum • Anthracite



SINE GLIDER

Colour options:
Gypsum • Anthracite

Sine Pitch:
80mm (3 1/8")

Roller Options

SINGLE STACK ► • PAIR STACK ►◄



ROLLER

Colour options:
Gypsum • Anthracite



SINE ROLLER

Colour options:
Gypsum • Anthracite

Sine Pitch:
60mm (2 3/8") • 80mm (3 1/8")



METALCOAT ROLLER

Colour options:
System Colour



METALCOAT SINE ROLLER

Colour options:
System Colour

Sine Pitch:
60mm (2 3/8") • 80mm (3 1/8")



METALCOAT RIPPLEFOLD ROLLER

Colour options:
System Colour

Fullness:
80% • 100%



! Return bends are not available.

- FINISHES**
- Shades** ☉☉☉ Alabaster • Barley • Bone • Burnt Ash • Charcoal • Clay • Cloud • Cocoa • Cream • Dove • Dusk • Earth • Flint • Frame Grey • Grey Moss • Lead • Millstone • Mineral • Moss • Oatmeal • Parchment • Raven • Smoke • Stone
 - Coat Options**
 - Matte** ☉
 - Satin** ☉
 - Gloss** ☉
 - Metallics** ☉☉ Antique Brass • Bronzed • Champagne • Cognac • Gold • Gunmetal • Pewter • Platinum
 - Anodics** ☉☉ Glimmer • Glow • Midnight • Night Sky • Sky • Storm • Sunrise • Sunset • Twilight
 - Organics** Ash Stone • Iron • Obsidian • Sand Stone
 - Ceramics** Available at +50% the cost of the standard finish | Blue Titanium • Burnt Bronze • Cobalt • Copper • Electrum • Frost • Golden Quartz • Graphite Black • Midnight Bronze • Serpentine • Titanium • Tungsten
 - Chromatics** Available at +50% the cost of the standard finish | Burnished Aluminum • Etched Aluminum • Matte Aluminum • Etched Graphite • Etched Black • Soft Black | Burnished Brass • Etched Brass • Soft Brass | Burnished Bronze • Etched Bronze • Soft Bronze

ø30mm (1 3/16")

ø38mm (1 1/2")

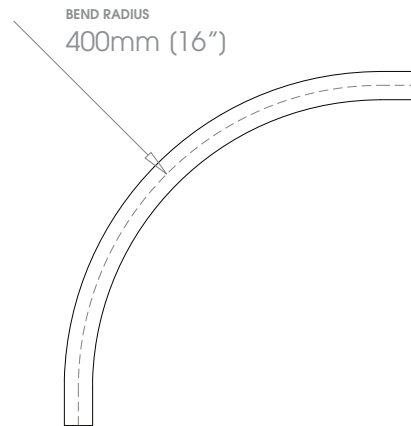
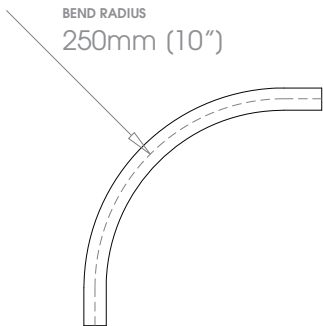

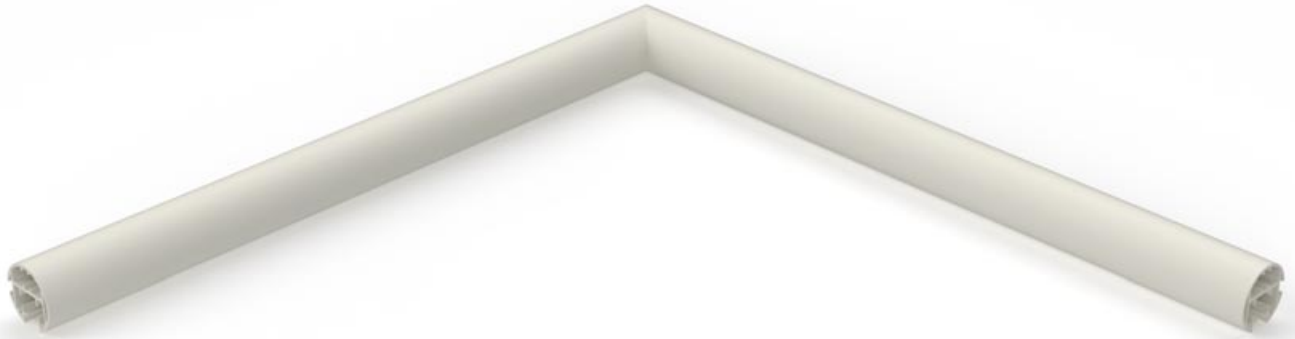

FINISHES

Coat Options
 Matte Ⓞ
 Satin Ⓞ
 Gloss Ⓞ

- Shades** ⓄⓄⓄ Alabaster • Barley • Bone • Burnt Ash • Charcoal • Clay • Cloud • Cocoa • Cream • Dove • Dusk • Earth • Flint • Frame Grey • Grey Moss
 Lead • Millstone • Mineral • Moss • Oatmeal • Parchment • Raven • Smoke • Stone
- Metallics** ⓄⓄ Antique Brass • Bronzed • Champagne • Cognac • Gold • Gunmetal • Pewter • Platinum
 Glimmer • Glow • Midnight • Night Sky • Sky • Storm • Sunrise • Sunset • Twilight
- Anodics**
Organics Ash Stone • Iron • Obsidian • Sand Stone
- Ceramics** Available at +50% the cost of the standard finish | Blue Titanium • Burnt Bronze • Cobalt • Copper • Electrum • Frost • Golden Quartz
 Graphite Black • Midnight Bronze • Serpentine • Titanium • Tungsten
- Chromatics** Available at +50% the cost of the standard finish | Burnished Aluminum • Etched Aluminum • Matte Aluminum
 Etched Graphite • Etched Black • Soft Black | Burnished Brass • Etched Brass • Soft Brass | Burnished Bronze • Etched Bronze • Soft Bronze

ø30mm (1 3/16")

ø38mm (1 1/2")

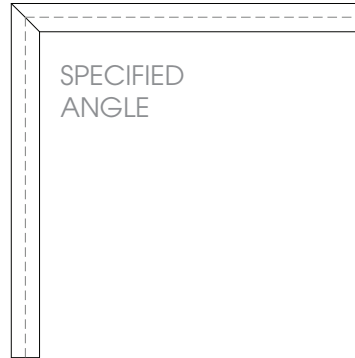
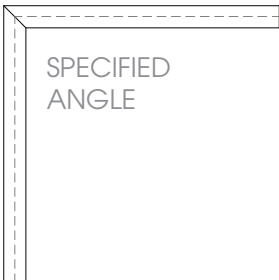



FINISHES

Coat Options

- Matte @
- Satin @
- Gloss @

- Shades** @@@ Cloud • Alabaster • Bone • Barley • Dusk • Ceramic • Cream • Mineral • Dove • Parchment • Oatmeal • Millstone • Stone • Clay • Grey Moss
Slate • Cocoa • Moss • Damson • Smoke • Frame Grey • Lead • Earth • Burnt Ash • Flint • Charcoal • Raven
- Metallics** @@ Platinum • Champagne • Gold • Cognac • Antique Brass • Gunmetal • Pewter • Bronzed
- Anodic Metals** Twilight • Glow • Sky • Sunrise • Storm • Glimmer • Sunset • Night Sky • Midnight
- Custom** See page 20 for details

ø30mm (1 3/16")

ø38mm (1 1/2")

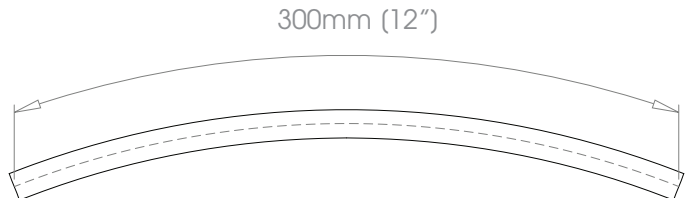
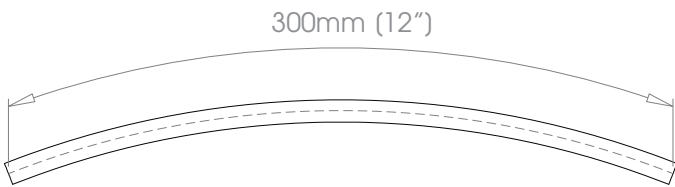



 Customised brackets available - See page 8

- FINISHES**
- Shades** @@@ Alabaster • Barley • Bone • Burnt Ash • Charcoal • Clay • Cloud • Cocoa • Cream • Dove • Dusk • Earth • Flint • Frame Grey • Grey Moss • Lead • Millstone • Mineral • Moss • Oatmeal • Parchment • Raven • Smoke • Stone
 - Coat Options**
 - Matte** @
 - Satin** @
 - Gloss** @
 - Metallics** @@@ Antique Brass • Bronzed • Champagne • Cognac • Gold • Gunmetal • Pewter • Platinum • Glimmer • Glow • Midnight • Night Sky • Sky • Storm • Sunrise • Sunset • Twilight
 - Anodics** @@@ Ash Stone • Iron • Obsidian • Sand Stone
 - Organics**
 - Ceramics** Available at +50% the cost of the standard finish | Blue Titanium • Burnt Bronze • Cobalt • Copper • Electrum • Frost • Golden Quartz • Graphite Black • Midnight Bronze • Serpentine • Titanium • Tungsten
 - Chromatics** Available at +50% the cost of the standard finish | Burnished Aluminum • Etched Aluminum • Matte Aluminum • Etched Graphite • Etched Black • Soft Black | Burnished Brass • Etched Brass • Soft Brass | Burnished Bronze • Etched Bronze • Soft Bronze

ø30mm (1 3/16")

ø38mm (1 1/2")

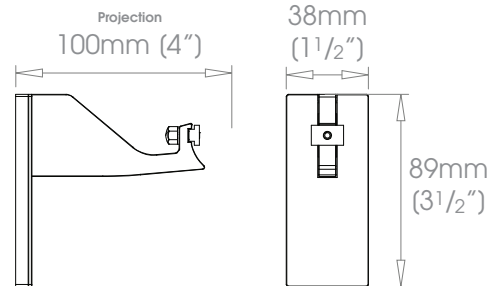
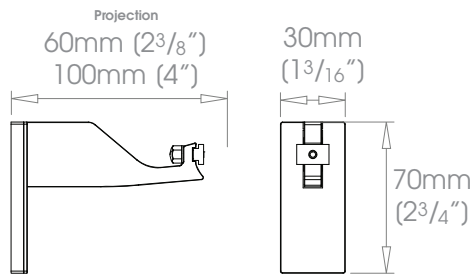



 Customised brackets available - See page 8

FINISHES	Shades ☉☉☉	Alabaster • Barley • Bone • Burnt Ash • Charcoal • Clay • Cloud • Cocoa • Cream • Dove • Dusk • Earth • Flint • Frame Grey • Grey Moss • Lead • Millstone • Mineral • Moss • Oatmeal • Parchment • Raven • Smoke • Stone
	Coat Options	
	Metallics ☉☉	Antique Brass • Bronzed • Champagne • Cognac • Gold • Gunmetal • Pewter • Platinum
	Anodics ☉☉	Glimmer • Glow • Midnight • Night Sky • Sky • Storm • Sunrise • Sunset • Twilight
	Organics	Ash Stone • Iron • Obsidian • Sand Stone
Ceramics	<i>Available at +50% the cost of the standard finish</i> Blue Titanium • Burnt Bronze • Cobalt • Copper • Electrum • Frost • Golden Quartz • Graphite Black • Midnight Bronze • Serpentine • Titanium • Tungsten	
Chromatics	<i>Available at +50% the cost of the standard finish</i> Burnished Aluminum • Etched Aluminum • Matte Aluminum • Etched Graphite • Etched Black • Soft Black Burnished Brass • Etched Brass • Soft Brass Burnished Bronze • Etched Bronze • Soft Bronze	

ø30mm (1 3/16")

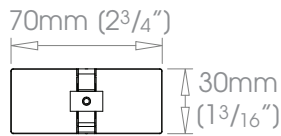
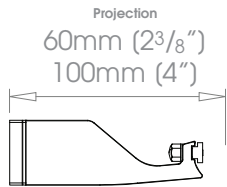

ø38mm (1 1/2")

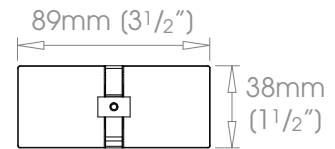
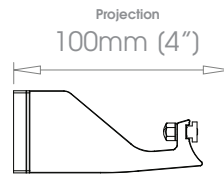



FINISHES

Coat Options

- Matte ⊗
- Satin ⊗
- Gloss ⊗

Metallics ⊗⊗

Anodics

Organics

Ceramics

Chromatics

Shades ⊗⊗⊗ Alabaster • Barley • Bone • Burnt Ash • Charcoal • Clay • Cloud • Cocoa • Cream • Dove • Dusk • Earth • Flint • Frame Grey • Grey Moss
Lead • Millstone • Mineral • Moss • Oatmeal • Parchment • Raven • Smoke • Stone

Antique Brass • Bronzed • Champagne • Cognac • Gold • Gunmetal • Pewter • Platinum

Glimmer • Glow • Midnight • Night Sky • Sky • Storm • Sunrise • Sunset • Twilight

Ash Stone • Iron • Obsidian • Sand Stone

Available at +50% the cost of the standard finish | Blue Titanium • Burnt Bronze • Cobalt • Copper • Electrum • Frost • Golden Quartz

Graphite Black • Midnight Bronze • Serpentine • Titanium • Tungsten

Available at +50% the cost of the standard finish | Burnished Aluminum • Etched Aluminum • Matte Aluminum

Etched Graphite • Etched Black • Soft Black | Burnished Brass • Etched Brass • Soft Brass | Burnished Bronze • Etched Bronze • Soft Bronze

ø30mm (1 3/16")

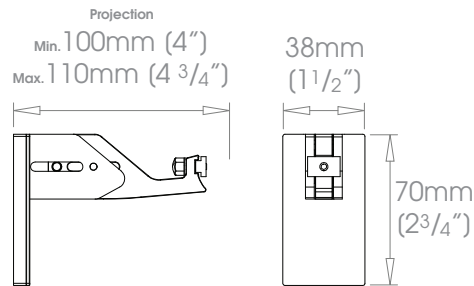

ø38mm (1 1/2")

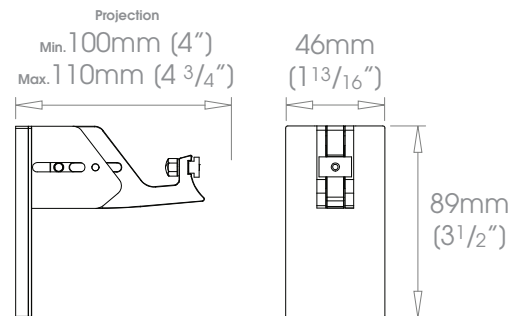



FINISHES **Shades** ☉☉☉ Alabaster • Barley • Bone • Burnt Ash • Charcoal • Clay • Cloud • Cocoa • Cream • Dove • Dusk • Earth • Flint • Frame Grey • Grey Moss
 Lead • Millstone • Mineral • Moss • Oatmeal • Parchment • Raven • Smoke • Stone
Coat Options **Metallics** ☉☉☉ Antique Brass • Bronzed • Champagne • Cognac • Gold • Gunmetal • Pewter • Platinum
Matte ☉ **Anodics** ☉☉☉ Glimmer • Glow • Midnight • Night Sky • Sky • Storm • Sunrise • Sunset • Twilight
Satin ☉ **Organics** Ash Stone • Iron • Obsidian • Sand Stone
Gloss ☉ **Ceramics** *Available at +50% the cost of the standard finish* | Blue Titanium • Burnt Bronze • Cobalt • Copper • Electrum • Frost • Golden Quartz
Chromatics *Available at +50% the cost of the standard finish* | Burnished Aluminum • Etched Aluminum • Matte Aluminum
 Etched Graphite • Etched Black • Soft Black | Burnished Brass • Etched Brass • Soft Brass | Burnished Bronze • Etched Bronze • Soft Bronze

ø30mm (1 3/16")

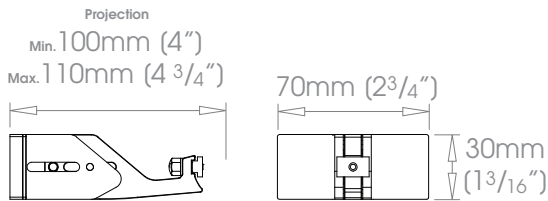

ø38mm (1 1/2")

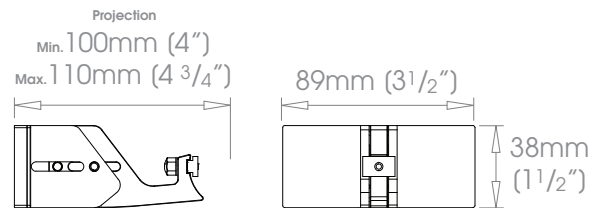



 Customised brackets available - See page 8

- FINISHES**
- Shades** ☉☉☉ Alabaster • Barley • Bone • Burnt Ash • Charcoal • Clay • Cloud • Cocoa • Cream • Dove • Dusk • Earth • Flint • Frame Grey • Grey Moss • Lead • Millstone • Mineral • Moss • Oatmeal • Parchment • Raven • Smoke • Stone
 - Coat Options**
 - Matte ☉
 - Satin ☉
 - Gloss ☉
 - Metallics** ☉☉ Antique Brass • Bronzed • Champagne • Cognac • Gold • Gunmetal • Pewter • Platinum
 - Anodics** ☉☉ Glimmer • Glow • Midnight • Night Sky • Sky • Storm • Sunrise • Sunset • Twilight
 - Organics** Ash Stone • Iron • Obsidian • Sand Stone
 - Ceramics** *Available at +50% the cost of the standard finish* | Blue Titanium • Burnt Bronze • Cobalt • Copper • Electrum • Frost • Golden Quartz • Graphite Black • Midnight Bronze • Serpentine • Titanium • Tungsten
 - Chromatics** *Available at +50% the cost of the standard finish* | Burnished Aluminum • Etched Aluminum • Matte Aluminum • Etched Graphite • Etched Black • Soft Black | Burnished Brass • Etched Brass • Soft Brass | Burnished Bronze • Etched Bronze • Soft Bronze

ø30mm (1 3/16")

ø38mm (1 1/2")

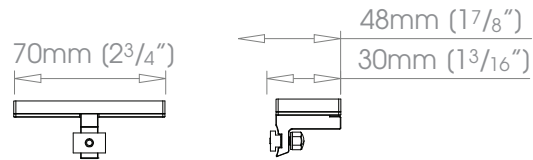
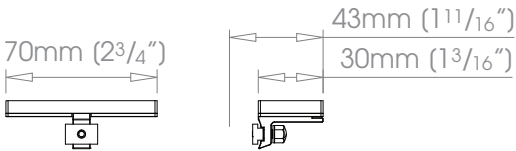

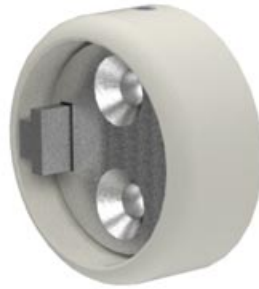

! Recess brackets are not suitable for use with flush ceiling brackets

- FINISHES**
- Shades** ☉☉☉ Alabaster • Barley • Bone • Burnt Ash • Charcoal • Clay • Cloud • Cocoa • Cream • Dove • Dusk • Earth • Flint • Frame Grey • Grey Moss • Lead • Millstone • Mineral • Moss • Oatmeal • Parchment • Raven • Smoke • Stone
 - Coat Options**
 - Metallics** ☉☉ Antique Brass • Bronzed • Champagne • Cognac • Gold • Gunmetal • Pewter • Platinum
 - Anodics** ☉☉ Glimmer • Glow • Midnight • Night Sky • Sky • Storm • Sunrise • Sunset • Twilight
 - Organics** ☉☉ Ash Stone • Iron • Obsidian • Sand Stone
 - Ceramics** ☉☉ Available at +50% the cost of the standard finish | Blue Titanium • Burnt Bronze • Cobalt • Copper • Electrum • Frost • Golden Quartz • Graphite Black • Midnight Bronze • Serpentine • Titanium • Tungsten
 - Chromatics** ☉☉ Available at +50% the cost of the standard finish | Burnished Aluminum • Etched Aluminum • Matte Aluminum • Etched Graphite • Etched Black • Soft Black | Burnished Brass • Etched Brass • Soft Brass | Burnished Bronze • Etched Bronze • Soft Bronze

ø30mm (1 3/16")

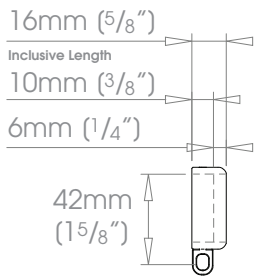

ø38mm (1 1/2")

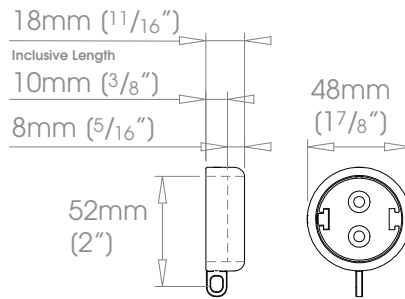



- FINISHES** **Shades** ☉☉☉ Alabaster • Barley • Bone • Burnt Ash • Charcoal • Clay • Cloud • Cocoa • Cream • Dove • Dusk • Earth • Flint • Frame Grey • Grey Moss
 Lead • Millstone • Mineral • Moss • Oatmeal • Parchment • Raven • Smoke • Stone
- Coat Options** **Metallics** ☉☉ Antiqued Brass • Bronzed • Champagne • Cognac • Gold • Gunmetal • Pewter • Platinum
Matte ☉ **Anodics** ☉☉ Glimmer • Glow • Midnight • Night Sky • Sky • Storm • Sunrise • Sunset • Twilight
Satin ☉ **Organics** Ash Stone • Iron • Obsidian • Sand Stone
Gloss ☉ **Ceramics** Available at +50% the cost of the standard finish | Blue Titanium • Burnt Bronze • Cobalt • Copper • Electrum • Frost • Golden Quartz
Chromatics Available at +50% the cost of the standard finish | Burnished Aluminum • Etched Aluminum • Matte Aluminum
 Etched Graphite • Etched Black • Soft Black | Burnished Brass • Etched Brass • Soft Brass | Burnished Bronze • Etched Bronze • Soft Bronze

F30mm (1³/₁₆") B30mm (1³/₁₆")

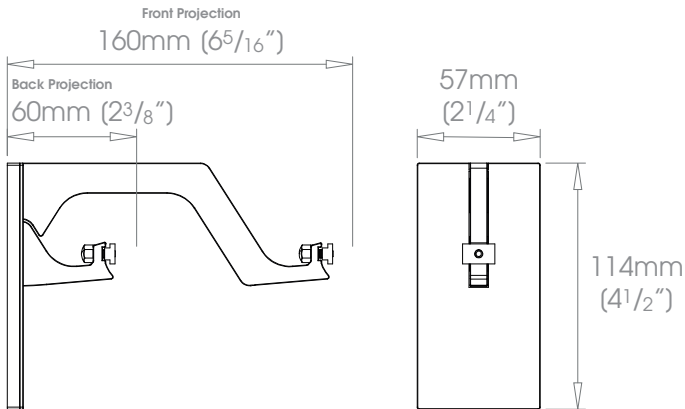

F38mm (1¹/₂") B30mm (1³/₁₆")

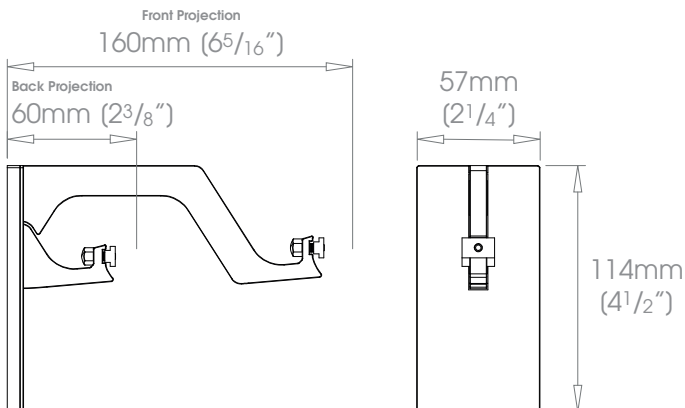



- FINISHES**
- Shades** ☉☉☉ Alabaster • Barley • Bone • Burnt Ash • Charcoal • Clay • Cloud • Cocoa • Cream • Dove • Dusk • Earth • Flint • Frame Grey • Grey Moss
Lead • Millstone • Mineral • Moss • Oatmeal • Parchment • Raven • Smoke • Stone
- Coat Options**
- Matte** ☉
Satin ☉
Gloss ☉
- Metallics** ☉☉☉ Antique Brass • Bronzed • Champagne • Cognac • Gold • Gunmetal • Pewter • Platinum
Anodics ☉☉☉ Glimmer • Glow • Midnight • Night Sky • Sky • Storm • Sunrise • Sunset • Twilight
- Organics** Ash Stone • Iron • Obsidian • Sand Stone
- Ceramics** Available at +50% the cost of the standard finish | Blue Titanium • Burnt Bronze • Cobalt • Copper • Electrum • Frost • Golden Quartz
Graphite Black • Midnight Bronze • Serpentine • Titanium • Tungsten
- Chromatics** Available at +50% the cost of the standard finish | Burnished Aluminum • Etched Aluminum • Matte Aluminum
Etched Graphite • Etched Black • Soft Black | Burnished Brass • Etched Brass • Soft Brass | Burnished Bronze • Etched Bronze • Soft Bronze

F38mm (1 1/2") B38mm (1 1/2")

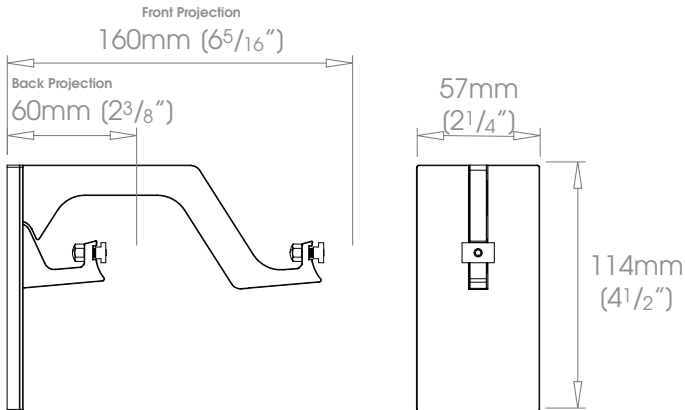



- FINISHES** **Shades** ☉☉☉ Alabaster • Barley • Bone • Burnt Ash • Charcoal • Clay • Cloud • Cocoa • Cream • Dove • Dusk • Earth • Flint • Frame Grey • Grey Moss
 Lead • Millstone • Mineral • Moss • Oatmeal • Parchment • Raven • Smoke • Stone
- Coat Options**
 Matte ☉
 Satin ☉
 Gloss ☉
- Metallics** ☉☉
Anodics ☉☉
Organics
Ceramics
- Chromatics**
- Available at +50% the cost of the standard finish* | Blue Titanium • Burnt Bronze • Cobalt • Copper • Electrum • Frost • Golden Quartz
 Graphite Black • Midnight Bronze • Serpentine • Titanium • Tungsten
Available at +50% the cost of the standard finish | Burnished Aluminum • Etched Aluminum • Matte Aluminum
 Etched Graphite • Etched Black • Soft Black | Burnished Brass • Etched Brass • Soft Brass | Burnished Bronze • Etched Bronze • Soft Bronze

F30mm (1³/₁₆") B30mm (1³/₁₆")

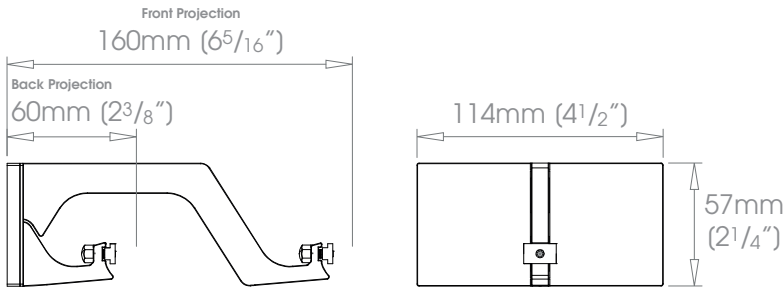

F38mm (1¹/₂") B30mm (1³/₁₆")

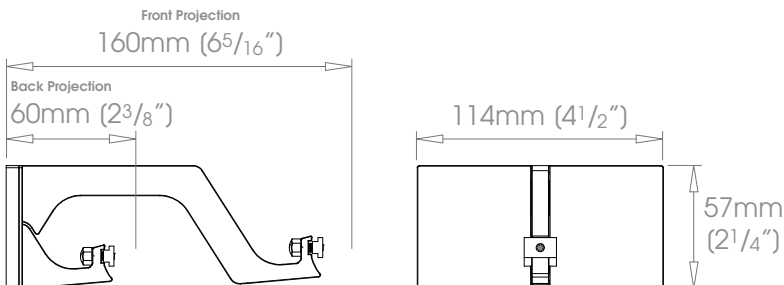



- FINISHES** **Shades** ☉☉☉ Alabaster • Barley • Bone • Burnt Ash • Charcoal • Clay • Cloud • Cocoa • Cream • Dove • Dusk • Earth • Flint • Frame Grey • Grey Moss
 Lead • Millstone • Mineral • Moss • Oatmeal • Parchment • Raven • Smoke • Stone
- Coat Options** **Metallics** ☉☉☉ Antique Brass • Bronzed • Champagne • Cognac • Gold • Gunmetal • Pewter • Platinum
 Lead • Millstone • Mineral • Moss • Oatmeal • Parchment • Raven • Smoke • Stone
- Matte** ☉ **Anodics** ☉☉☉ Glimmer • Glow • Midnight • Night Sky • Sky • Storm • Sunrise • Sunset • Twilight
 Satin ☉ **Organics** ☉☉☉ Ash Stone • Iron • Obsidian • Sand Stone
 Gloss ☉ **Ceramics** ☉☉☉ Available at +50% the cost of the standard finish | Blue Titanium • Burnt Bronze • Cobalt • Copper • Electrum • Frost • Golden Quartz
 Graphite Black • Midnight Bronze • Serpentine • Titanium • Tungsten
- Chromatics** ☉☉☉ Available at +50% the cost of the standard finish | Burnished Aluminum • Etched Aluminum • Matte Aluminum
 Etched Graphite • Etched Black • Soft Black | Burnished Brass • Etched Brass • Soft Brass | Burnished Bronze • Etched Bronze • Soft Bronze

F38mm (1 1/2") B38mm (1 1/2")

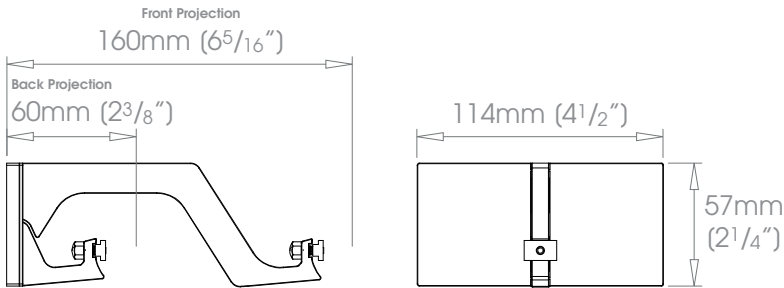



- FINISHES**
- | | |
|---------------------|---|
| Shades ☉☉☉ | Alabaster • Barley • Bone • Burnt Ash • Charcoal • Clay • Cloud • Cocoa • Cream • Dove • Dusk • Earth • Flint • Frame Grey • Grey Moss • Lead • Millstone • Mineral • Moss • Oatmeal • Parchment • Raven • Smoke • Stone |
| Coat Options | |
| Matte ☉ | |
| Satin ☉ | |
| Gloss ☉ | |
| Metallics ☉☉ | Antique Brass • Bronzed • Champagne • Cognac • Gold • Gunmetal • Pewter • Platinum |
| Anodics ☉☉ | Glimmer • Glow • Midnight • Night Sky • Sky • Storm • Sunrise • Sunset • Twilight |
| Organics | Ash Stone • Iron • Obsidian • Sand Stone |
| Ceramics | <i>Available at +50% the cost of the standard finish</i> Blue Titanium • Burnt Bronze • Cobalt • Copper • Electrum • Frost • Golden Quartz • Graphite Black • Midnight Bronze • Serpentine • Titanium • Tungsten |
| Chromatics | <i>Available at +50% the cost of the standard finish</i> Burnished Aluminum • Etched Aluminum • Matte Aluminum • Etched Graphite • Etched Black • Soft Black Burnished Brass • Etched Brass • Soft Brass Burnished Bronze • Etched Bronze • Soft Bronze |

F30mm (1³/₁₆") B30mm (1³/₁₆")

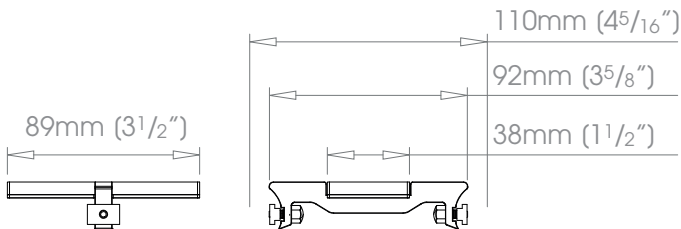

F38mm (1¹/₂") B38mm (1¹/₂")

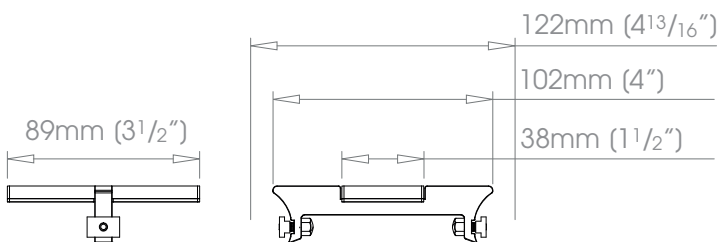



FINISHES

Coat Options
 Matte @
 Satin @
 Gloss @

- Shades** @@@ Alabaster • Barley • Bone • Burnt Ash • Charcoal • Clay • Cloud • Cocoa • Cream • Dove • Dusk • Earth • Flint • Frame Grey • Grey Moss
 Lead • Millstone • Mineral • Moss • Oatmeal • Parchment • Raven • Smoke • Stone
- Metallics** @@ Antique Brass • Bronzed • Champagne • Cognac • Gold • Gunmetal • Pewter • Platinum
 Glimmer • Glow • Midnight • Night Sky • Sky • Storm • Sunrise • Sunset • Twilight
- Anodics**
Organics Ash Stone • Iron • Obsidian • Sand Stone
- Ceramics** Available at +50% the cost of the standard finish | Blue Titanium • Burnt Bronze • Cobalt • Copper • Electrum • Frost • Golden Quartz
 Graphite Black • Midnight Bronze • Serpentine • Titanium • Tungsten
- Chromatics** Available at +50% the cost of the standard finish | Burnished Aluminum • Etched Aluminum • Matte Aluminum
 Etched Graphite • Etched Black • Soft Black | Burnished Brass • Etched Brass • Soft Brass | Burnished Bronze • Etched Bronze • Soft Bronze

Seamless

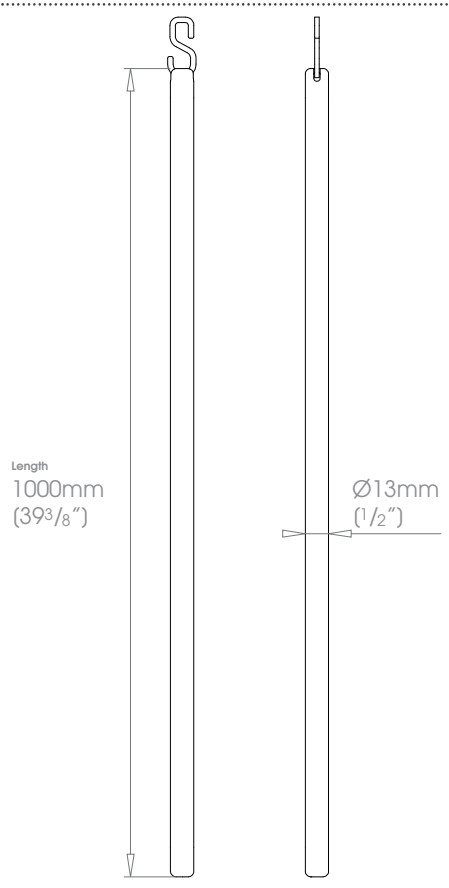

CONTACT

www.bradleycollection.com



UK & REST OF THE WORLD

☎ +44 (0)1449 722 724

✉ info@bradleycollection.com

USA & CANADA

☎ +1 (310) 815 8255

✉ info.us@bradleycollection.com

LONDON SHOWROOM

☎ +44 (0)207 871 7793

✉ showroom@studiotwochelsea.com

THE BRADLEY COLLECTION



Industry Partner

Supporting the interior design profession

CEDIA
MEMBER

Specialised fixings for mounting brackets will be required in certain situations and are not provided as standard. Steel items are not recommended for damp conditions such as shower rooms. Crystal finials should not be positioned in direct sunlight, and are not suitable for use in conservatories.

The Bradley Collection reserves the right to modify design and materials without prior notice as part of a process of continual product improvement. Due to printing limitations, colours in this brochure may not be accurate.

Products are protected by Design Rights, under provisions of Copyright, Designs & Patents Act 1988. Bradley® and The Bradley Collection® are registered Community trademarks of The Bradley Collection Ltd. in Europe and registered trademarks of the Bradley Collection, Inc. in the USA. Gliderpole is a registered trademark of The Bradley Collection Ltd in the UK.

The Bradley Collection Ltd Lion Barn • Maitland Road • Needham Market • Suffolk • IP6 8NS • UK
The Bradley Collection Inc 10866 Washington Blvd #1275 • Culver City • CA 90232 • USA

Published: 1125 • Copyright © The Bradley Collection Ltd. 2025