

# CONTACT

[www.bradleycollection.com](http://www.bradleycollection.com)



## UK & REST OF THE WORLD

☎ +44 (0)1449 722 724

✉ [info@bradleycollection.com](mailto:info@bradleycollection.com)

## USA & CANADA

☎ +1 (310) 815 8255

✉ [info.us@bradleycollection.com](mailto:info.us@bradleycollection.com)



GLIDERPOLE<sup>®</sup>

the**bradley**collection

Specialised fixings for mounting brackets will be required in certain situations and are not provided as standard. Steel items are not recommended for damp conditions such as shower rooms. Crystal finials and acrylic poles should not be positioned in direct sunlight, and are not suitable for use in conservatories. Brass items are supplied unlacquered and will tarnish over time.

The Bradley Collection reserves the right to modify design and materials without prior notice as part of a process of continual product improvement. Due to printing limitations, colours in this brochure may not be accurate.

Products are protected by Design Rights, under provisions of Copyright, Designs & Patents Act 1988. Bradley®, The Bradley Collection® and  Logo are registered Community trademarks of The Bradley Collection Ltd. in Europe and registered trademarks of the Bradley Collection, Inc. in the USA.

**The Bradley Collection Ltd** Lion Barn • Maitland Road • Needham Market • Suffolk • IP6 8NS • UK

Printed: 0821 • Copyright © The Bradley Collection Ltd. 2021



# GLIDERPOLE®

This sophisticated collection is the epitome of modern living. The design is sharp, streamlined and purposeful, whilst the choice of colour and finish ensures a truly individual result.

**Pictured:** Round ø50mm (2") Gliderpole® - Corded - Flush End Cap - Gold - Gloss

**Interior styling & decoration:** Dilly Orme @dillyorme

**Photography:** David Parmiter @davidparmitterphotography

## HAND DRAWN

The smooth running hand drawn option is available in four styles; Square • Flat • Ø30mm (1 3/16") • 50mm (2"). All benefit from the new thoughtful detailing of concealed end stops.



## CORDED

The innovative, embedded cording solution is available in three options, Square • Ø30mm (1 3/16") • 50mm (2"). All options allow a single or a twin cord which sits discreetly behind the curtain. A colour coordinated metal cord retainer is supplied as standard, for child safety.



## LENGTH

Gliderpole can be supplied to any length<sup>®</sup> allowing the curtains to travel freely across even the longest systems.



## WAVE®

The ubiquitous Wave® heading is accommodated through all Gliderpole options.

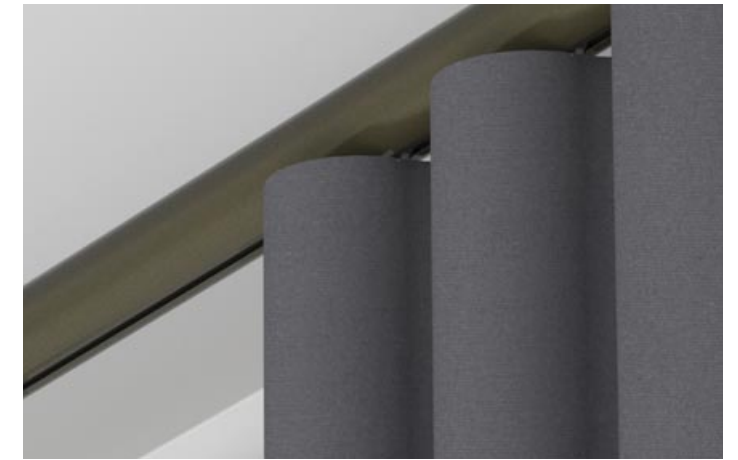

## HEAVY DUTY

New Heavy Duty face fixed brackets and improved adjustable brackets have been added to allow easy installation even in challenging situations. Wall brackets have a magnetic cover plate for hidden fixings. Brackets can also be supplied to custom lengths and designs.

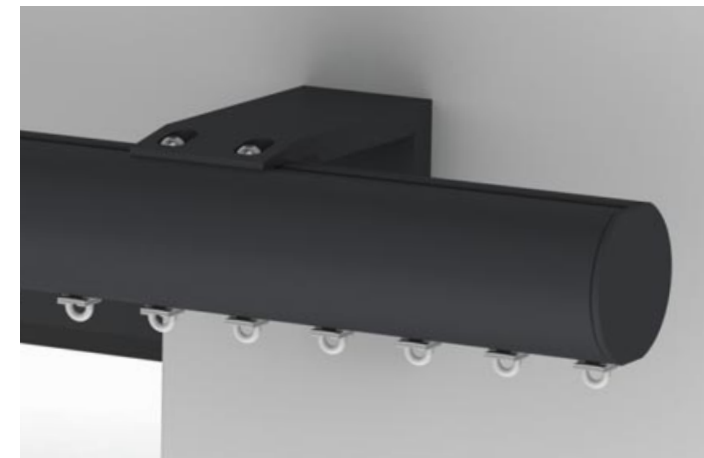

## BENT TO SHAPE

Gliderpole is the optimal solution for bends and curves. Precision bending and smooth running gliding systems combine to provide superb functionality.

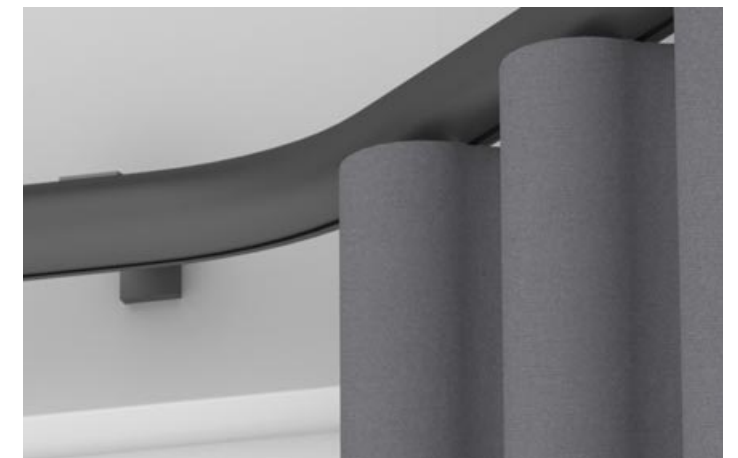

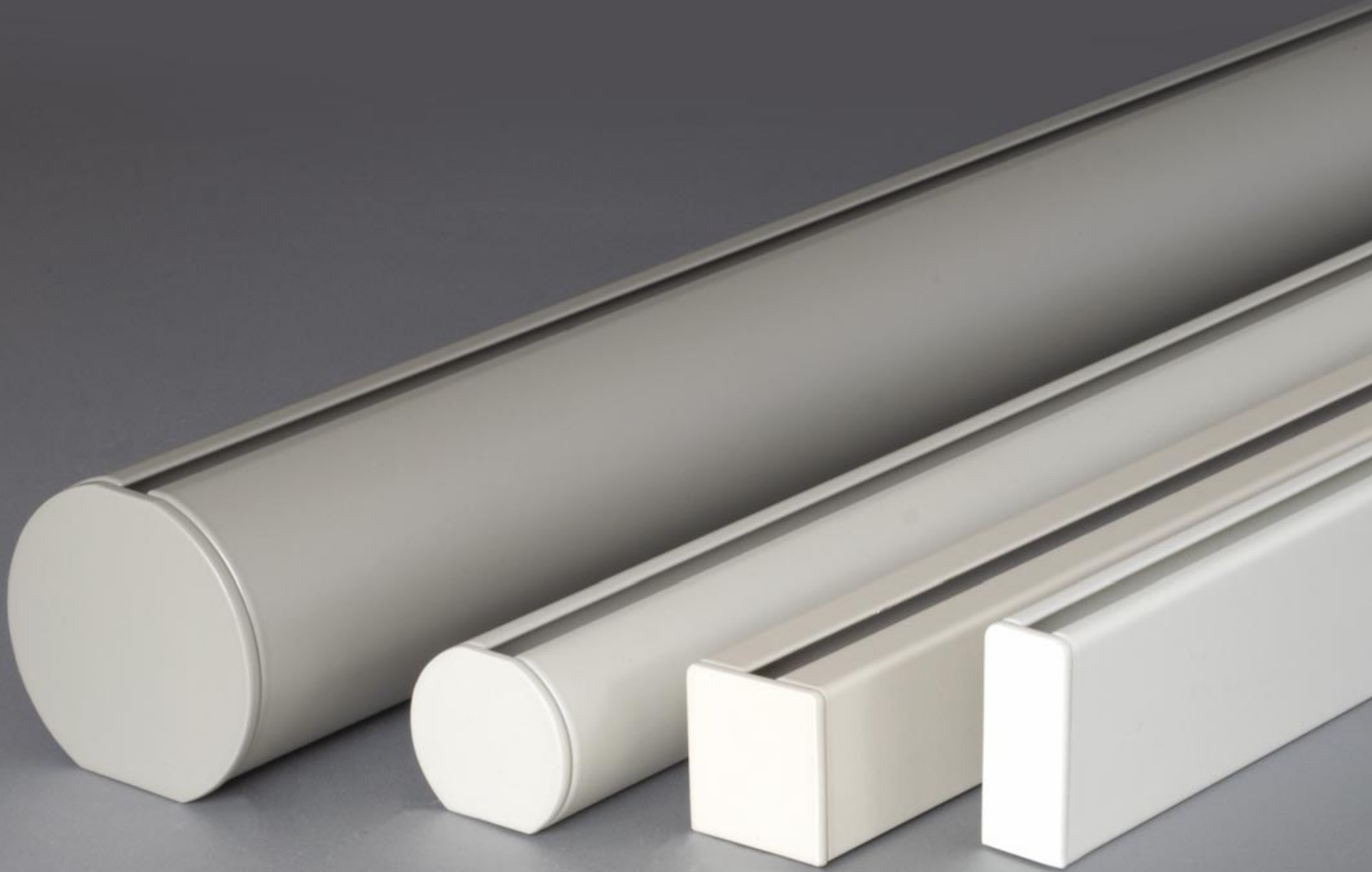

**Pictured left to right:**  
 Round  $\varnothing$ 50mm (2") Gliderpole® - Hand Drawn • Flush End Cap • Millstone Matte  
 Round  $\varnothing$ 30mm (1 1/8") Gliderpole® - Hand Drawn • Flush End Cap • Dove - Matte  
 Square H27mm (1 1/8") Gliderpole® - Hand Drawn • Flush End Cap • Mineral - Matte  
 Flat H36mm (1 7/16") Gliderpole® - Hand Drawn • Flush End Cap • Bone - Matte

# FINISHES

This stunning palette of colours and finishes is available on all Gliderpoles and components, with a choice of coat options throughout.

## Coat Options

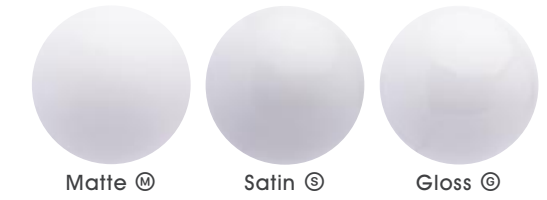

Cloud M S G	Barley M S G	Bone M S G	Cream M S G	Parchment M S G
Mineral M S G	Dove M S G	Millstone M S G	Clay M S G	Cocoa M S G
Alabaster M S G	Dusk M S G	Ceramic M S G	Slate M S G	Flint M S G
Damson M S G	Moss M S G	Smoke M S G	Frame Grey M S G	Raven M S G
Platinum S G	Champagne S G	Gold S G	Cognac S G	Gunmetal S G
Pewter S G	Antique Brass S G	Bronzed S G	Natural Silver	

Due to printing limitations colours in this brochure may not be accurate  
 Samples are available on request - [www.bradleycollection.com/samples/](http://www.bradleycollection.com/samples/)



**Pictured:** Round ø50mm (2") Gliderpole® - Hand Drawn • Flush Stud • Old Brass

Due to printing limitations colours in this brochure may not be accurate.  
 Samples are available on request - [www.bradleycollection.com/samples/](http://www.bradleycollection.com/samples/)

## FINISHES

### FLUID METAL™

At the cutting edge of metal finishing sits Fluid Metal. A first for drapery hardware, this innovative specialist finishing technique allows authentic metal coatings to be applied onto any substrate. For the first time, a brass or bronze coated Gliderpole becomes a reality.



### FINIAL & BRACKET ONLY FINISHES



### POLE ONLY FINISHES

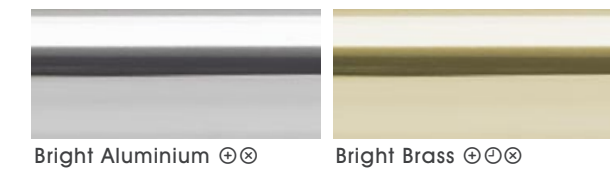

⊕ A finishing charge will apply    ⊗ Longer lead-times will apply    ⊗ Not available on Square or 50mm (2") poles  
 ⊕ Fluid Metal finishes are supplied unlacquered and will tarnish over time, a clear lacquer may be applied on request as a custom finish    ✎ Fluid Metal finishes are hand produced, finish may vary.

# FINIALS

This design edit allows Gliderpole to express different personalities, from the minimalist to the flamboyant.

For even greater choice, finial designs from the Mio Collection may also be specified.



**Flush End Cap** - Supplied as standard

Square H27mm (1 1/16") Inclusive Length 3mm (1/8")  
 Flat H36mm (1 7/16") Inclusive Length 3mm (1/8")  
 Round ø30mm (1 3/16") Inclusive Length 3mm (1/8")  
 Round ø50mm (2") Inclusive Length 3mm (1/8")



**Stud**

Round ø30mm (1 3/16") Inclusive Length 12mm (1/2")  
 Round ø50mm (2") Inclusive Length 18mm (1 1/16")



**Pebble**

Round ø30mm (1 3/16") Inclusive Length 42mm (1 5/8")  
 Round ø50mm (2") Inclusive Length 68mm (2 11/16")



**Flush Stud**

Square H27mm (1 1/16") Inclusive Length 12mm (1/2")  
 Flat H36mm (1 7/16") Inclusive Length 12mm (1/2")  
 Round ø30mm (1 3/16") Inclusive Length 12mm (1/2")  
 Round ø50mm (2") Inclusive Length 18mm (1 1/16")



**Disc**

Round ø30mm (1 3/16") Inclusive Length 12mm (1/2")  
 Round ø50mm (2") Inclusive Length 18mm (1 1/16")



**Ball**

Round ø30mm (1 3/16") Inclusive Length 66mm (2 5/8")  
 Round ø50mm (2") Inclusive Length 112mm (4 7/16")



**Halo**

ø30mm (1 3/16") Inclusive Length 5mm (3/16")  
 ø50mm (2") Inclusive Length 2mm (1/16")



**Globe**

ø30mm (1 3/16") Inclusive Length 73mm (2 7/8")  
 ø50mm (2") Inclusive Length 114mm (4 1/2")



**Ribbed Globe**

ø30mm (1 3/16") Inclusive Length 73mm (2 7/8")  
 ø50mm (2") Inclusive Length 114mm (4 1/2")



**Templar**

ø30mm (1 3/16") Inclusive Length 79mm (3 1/8")  
 ø50mm (2") Inclusive Length 119mm (4 11/16")

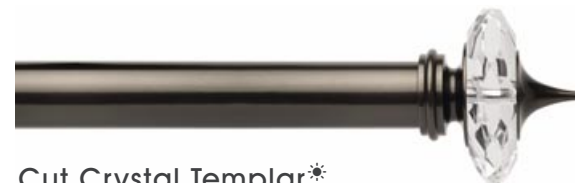

**Cut Crystal Templar\***

ø50mm (2") Inclusive Length 119mm (4 11/16")



**Squat Globe**

ø30mm (1 3/16") Inclusive Length 53mm (2 1/8")  
 ø50mm (2") Inclusive Length 81mm (3 1/16")



**Crystal Globe\***

ø30mm (1 3/16") Inclusive Length 73mm (2 7/8")  
 ø50mm (2") Inclusive Length 114mm (4 1/2")



**Flute**

ø30mm (1 3/16") Inclusive Length 73mm (2 7/8")  
 ø50mm (2") Inclusive Length 114mm (4 1/2")



**Crystal Templar\***

ø30mm (1 3/16") Inclusive Length 79mm (3 1/8")  
 ø50mm (2") Inclusive Length 119mm (4 11/16")





**Charm**

ø30mm (1 3/16") Inclusive Length 69mm (2 11/16")  
 ø50mm (2") Inclusive Length 117mm (4 5/8")

\*: Crystal Finials should not be positioned in direct sunlight

## SINGLE BRACKETS

Side	Mid	Diameter	Projection from wall to pole centre	Side Fixing plate size	Mid Fixing plate size
		Square H27mm (1 1/16")	60mm (2 3/8"), 100mm (4")	w32mm (1 1/4") x H70mm (2 3/4")	w32mm (1 1/4") x H38mm (1 1/2")
		Flat H36mm (1 7/16")	60mm (2 3/8"), 100mm (4")	w32mm (1 1/4") x H70mm (2 3/4")	w32mm (1 1/4") x H38mm (1 1/2")
		Round ø30mm (1 3/16")	60mm (2 3/8"), 100mm (4")	w32mm (1 1/4") x H70mm (2 3/4")	w32mm (1 1/4") x H38mm (1 1/2")
		Round ø50mm (2")	60mm (2 3/8"), 100mm (4")	w32mm (1 1/4") x H70mm (2 3/4")	w32mm (1 1/4") x H38mm (1 1/2")

Side Heavy Duty	Mid Heavy Duty	Diameter	Projection from wall to pole centre	Side Fixing plate size	Mid Fixing plate size
		Square H27mm (1 1/16")	100mm (4"), 140mm (5 1/2")	w47mm (1 7/8") x H76mm (3")	w47mm (1 7/8") x H36mm (1 7/16")
		Flat H36mm (1 7/16")	100mm (4"), 140mm (5 1/2")	w47mm (1 7/8") x H76mm (3")	w47mm (1 7/8") x H36mm (1 7/16")
		Round ø30mm (1 3/16")	100mm (4"), 140mm (5 1/2")	w47mm (1 7/8") x H76mm (3")	w47mm (1 7/8") x H36mm (1 7/16")
		Round ø50mm (2")	100mm (4"), 140mm (5 1/2")	w47mm (1 7/8") x H76mm (3")	w47mm (1 7/8") x H36mm (1 7/16")

Flush Light Duty	Diameter	Drop from ceiling to top of pole	Fixing plate size
	Square H27mm (1 1/16")	3mm (1/8")	w20mm (1 3/16") x L50mm (2")
	Flat H36mm (1 7/16")	3mm (1/8")	w20mm (1 3/16") x L50mm (2")
	Round ø30mm (1 3/16")	3mm (1/8")	w20mm (1 3/16") x L50mm (2")

Flush Heavy Duty	Diameter	Drop from ceiling to top of pole	Fixing plate size
	Square H27mm (1 1/16")	3mm (1/8")	w40mm (1 9/16") x L59mm (2 3/16")
	Flat H36mm (1 7/16")	3mm (1/8")	w40mm (1 9/16") x L59mm (2 3/16")
	Round ø30mm (1 3/16")	3mm (1/8")	w40mm (1 9/16") x L59mm (2 3/16")
	Round ø50mm (2")	3mm (1/8")	w40mm (1 9/16") x L59mm (2 3/16")



## RECESS BRACKETS

Recess with hook stop	Diameter	Depth off wall	Fixing plate size
	Square H27mm (1 1/16")	14mm (9/16")	w42mm (1 11/16") x H27mm (1 1/16")
	Flat H36mm (1 7/16")	14mm (9/16")	w31mm (1 1/4") x H36mm (1 7/16")
	Round ø30mm (1 3/16")	14mm (9/16")	w40mm (1 9/16") x H31mm (1 1/4")
	Round ø50mm (2")	14mm (9/16")	w64mm (1 1/2") x H51mm (2")

## ADJUSTABLE BRACKETS

Side	Mid	Diameter	Projection from wall to pole centre	Side Fixing plate size	Mid Fixing plate size
		Square H27mm (1 1/16")	Min.80mm (3 1/8") Max.130mm (5 1/8")	w47mm (1 7/8") x H76mm (3")	w47mm (1 7/8") x H36mm (1 7/16")
		Flat H36mm (1 7/16")	Min.80mm (3 1/8") Max.130mm (5 1/8")	w47mm (1 7/8") x H76mm (3")	w47mm (1 7/8") x H36mm (1 7/16")
		Round ø30mm (1 3/16")	Min.80mm (3 1/8") Max.130mm (5 1/8")	w47mm (1 7/8") x H76mm (3")	w47mm (1 7/8") x H36mm (1 7/16")
		Round ø50mm (2")	Min.80mm (3 1/8") Max.130mm (5 1/8")	w47mm (1 7/8") x H76mm (3")	w47mm (1 7/8") x H36mm (1 7/16")

## DOUBLE BRACKETS

Side	Mid	Diameter	Projection from wall to pole centre	Side Fixing plate size	Mid Fixing plate size
		Square H27mm (1 1/16")	F140mm (5 1/2") B adjustable	w47mm (1 7/8") x H76mm (3")	w47mm (1 7/8") x H36mm (1 7/16")
		Flat H36mm (1 7/16")	F140mm (5 1/2") B adjustable	w47mm (1 7/8") x H76mm (3")	w47mm (1 7/8") x H36mm (1 7/16")
		Round ø30mm (1 3/16")	F140mm (5 1/2") B adjustable	w47mm (1 7/8") x H76mm (3")	w47mm (1 7/8") x H36mm (1 7/16")
		Round ø50mm (2")	F140mm (5 1/2") B adjustable	w47mm (1 7/8") x H76mm (3")	w47mm (1 7/8") x H36mm (1 7/16")

## CUSTOM BRACKETS

A bespoke design service is offered to ensure solutions in even the most challenging installations.

				
<b>Custom Projection</b> Specify the exact projection needed.	<b>Custom Fixing Plate</b> Relevant where space is restricted or weight is a concern.	<b>Uplift</b> Helps negotiate cornice and similar architectural features.	<b>Ceiling Brackets</b> Specify exact projection required from ceiling.	<b>Angled Brackets</b> The solution for tight and awkward locations.

# GLIDING OPTIONS

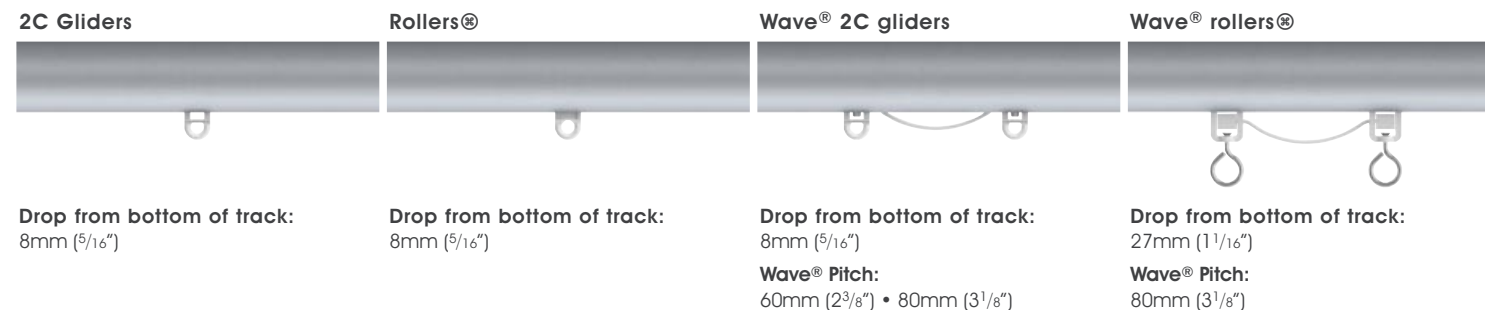

# POLES

Poles are cut, bent and curved to suit individual requirements. When calculating the length of your pole, remember to allow tolerance beyond the width of the frame for the curtains to stack back to the edge of the window.

Maximum pole length in one piece 4.0m (157").

Poles exceeding the maximum length will be cut into equal parts unless otherwise specified. A pole joiner will be supplied.

Twin cord systems are always supplied in an even number of parts & will be supplied in a minimum of two sections.

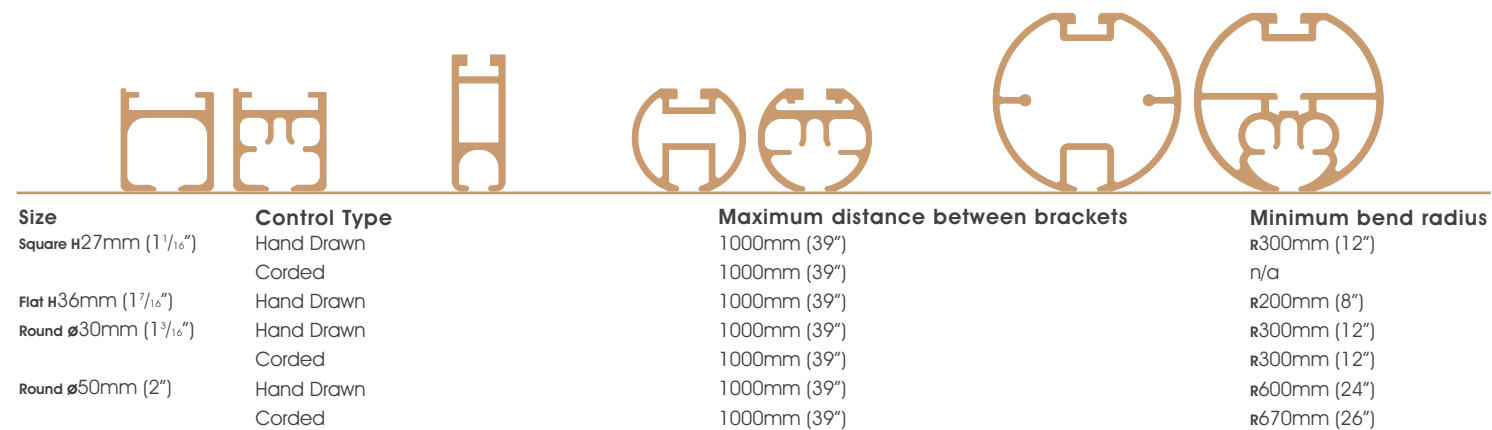

# ACCESSORIES

## Draw Rods

Fine Standard



Draw rod length:  
1000mm (39 3/8")  
Custom lengths available to order

## Cord Retainer



All corded tracks are supplied as standard with a metal cord retainer. This ensures that all cords are safely secured to the wall and complies with BS EN 13120:2009+A12014.

This will be supplied in the same finish as the system, unless advised otherwise.



Fixing plate size:  
Ø60mm (2 3/8")