

Datasheet MoveLite Wirefree		Range	MoveLite WireFree 35 RTS
		Part no.	MoveLite : 1240365, 1240366 (SA version), 1241189 (Taiwan)
		Technology	RTS
Motor mechanical characteristics	Nominal torque	Nm	0.6
	Maximum stall torque	Nm	0.8
	No load speed	rpm	105
	Nominal speed	rpm	105
	Working temperature	°C (°F)	0°C to +60°C 85%HR at 35°C (+32°F to +140°F 85%HR at 95°F)
	Storage temperature (for motor only)	°C (°F)	-30°C to +80°C 85%HR at 35°C (-22°F to +176°F 85%HR at 95°F)
	Storage temperature (Battery pack)< 3 months	°C	0 - 35
	Storage temperature (Battery pack)> 3 months	°C	15 - 25
	Manual operation		YES
	Type of limit		Adjustable limits
	Limit switch accuracy	mm	±10
	Protection index	IP	30
	Soft stop		No
	Soft start		No
	Electrical characteristics	Noise level (Power) ⁽³⁾	dB(A)
Noise level (Pressure) ⁽³⁾		dB(A)	38
Current (Sleep mode)		mA	<0.2mA
Current (wakeup mode)		mA	8~9mA
Approx. Net weight of the motor		g	1024
Voltage range		Vac	NA
Frequency range		Hz	NA
Stand by power		W	< 0.003
Power adapter Current		A	NA
Power adapter Voltage		Vdc	NA
Battery pack capacity		mAh	2000
Charging temperature		°C	0 - 40
Charge time		hour	<9
Power cable type			NA
Power cable number of wire			NA
Power cable wire section (Ø)	mm ²	NA	
Control connector		NA	
Control method		RTS remote control	
Dry contact minimum closure time	ms	NA	
Voltage in control line (supplied by the motor)	V	NA	
Maximum voltage drop in DCT control line	V	NA	
Insulation class		Class III	
Maximum running time in one direction ⁽⁴⁾		2min 30s	
Radio standards		EN 301 489-3, EN 300 220-3	
Radio protocol		Somfy RTS protocol U80	
Radio frequency	MHz	433,42 ± 0,1	
Receiver sensitivity	dBm	-103	
Modulation type		ASK type A1 (amplitude modulation)	
Radio range	m	200 m in free field	
Antenna		Integrated	
Rolling code		65536 codes	
Number of RTS transmitter		12 maximum	
Standards & Patents	Certifications		CE, CB
	Patents		Patents pending

⁽⁴⁾ Values given at different speed regulation settings (20 / 17,5 / 15 / 12,5 cm/s)





⁽²⁾ Maximum speed at nominal torque

⁽³⁾ Indicative and according to SOMFY measurement standards

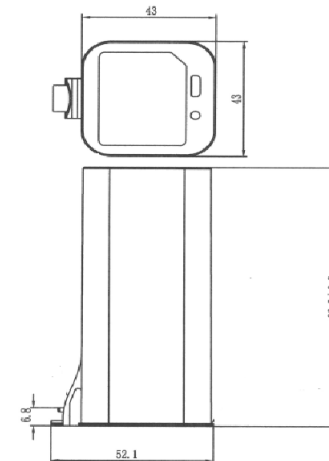
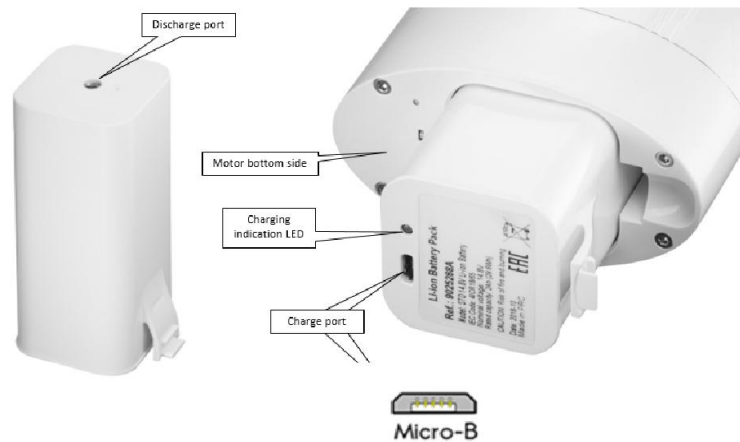
⁽⁴⁾ Repeatedly operating the motor for extended periods may trigger thermal protection, which will require time to lower to room temperature.

Name	Battery Pack for Movelite WireFree			
Type	STD 14.8V Li-ion battery pack			
Reference	9025268, 9026556 (SASO)			
Material	Plastic			
Color	White			
Size	43x52x96.5mm			
Input accepted chargers	9025269 EU PLUG - Type C	9025765 US PLUG - Type A	9025764 CN PLUG	9025766 UK PLUG - Type G
Input nominal voltage	5VDC			
Input connector	USB 2.0 Micro-B			
Maximum charge current	2 A			
Continuous working current	2 A			
Pulse discharge current	4 A			
Maximum distance between battery pack and USB Charger	4 m			
Protection against polarity reversal	n/a			
Battery capacity	2000 mAh (29.6Wh) Built in Li-ion battery			
Output range of supply voltage	12~16.8V			
Output connector	n/a			
Output cable length	n/a			
Index protection rating	For indoor use only			
Temperature range (working)	0°C - 60°C			
Temperature range (storage)	Short term storage (≤three months) 0~35°C 30~75%RH Long term storage (>three months) 20±5°C 35-70%RH			
Temperature range (charging)	0°C - 40°C			
Autonomy	The autonomy depends on the curtain application, the user's behavior and the user environment			
Charging indication LED	Red Charging is on-going Green Charging is full			
Weight	237g			



Name	USB Charger for Movelite WireFree RTS		
Type	USB 5V 1A		
Reference Number	9025269	USB charger with EU plug	
	9025764	USB charger with CN plug	
	9025765	USB charger with US plug	
	9025766	USB charger with UK plug	
Material	Plastic		
Color	Black		
Input accepted chargers	not applicable		
Input nominal voltage	100~240VAC		
Input nominal frequency	50/60 Hz		
Input connector	USB 2.0 Male Cable (Type A)		
Maximum distance between battery pack and USB charger	4m with USB 2.0 cable		
Protection against polarity reversal	Yes		
Battery capacity	not applicable		
Output range of supply voltage	5VDC		
Output current	1 A		
Output connector	USB 2.0 Female (Type A)		
Output cable length	not applicable		
Index protection rating	For indoor use only		
Temperature range (working)	0°C - 40°C		
Temperature range (storage)	-20°C - +60°C		
Autonomy	not applicable		
Weight	44g for USB charger with UK plug		
Picture	9025269 EU PLUG - Type C : 	9025765 US PLUG - Type A : 	9025764 CN PLUG :  9025766 UK PLUG - Type G : 
Size	