

CONTACT

www.bradleycollection.com



UK & REST OF THE WORLD

☎ +44 (0)1449 722 724

✉ info@bradleycollection.com

USA & CANADA

☎ +1 (310) 815 8255

✉ info.us@bradleycollection.com

LONDON SHOWROOM

☎ +44 (0)207 871 7793

✉ showroom@studiotwochelsea.com



FLOAT

THE BRADLEY
COLLECTION

CEDIA
MEMBER

Specialised fixings for mounting brackets will be required in certain situations and are not provided as standard.
Steel items are not recommended for damp conditions such as shower rooms.
Crystal finials should not be positioned in direct sunlight, and are not suitable for use in conservatories.
Fluid Metal items are supplied unlacquered and will tarnish over time.

The Bradley Collection reserves the right to modify design and materials without prior notice as part of a process of continual product improvement. Due to printing limitations, colours in this brochure may not be accurate.

Products are protected by Design Rights, under provisions of Copyright, Designs & Patents Act 1988.
Bradley®, The Bradley Collection® and  Logo are registered Community trademarks of The Bradley Collection Ltd. in Europe and registered trademarks of the Bradley Collection, Inc. in the USA.

The Bradley Collection Ltd Lion Barn • Maitland Road • Needham Market • Suffolk • IP6 8NS • UK

Printed: 1023 • Copyright © The Bradley Collection Ltd. 2023



FLOAT

A contemporary re-imagining of the traditional pole and ring, with perfected functionality and a modern style.

This collection features rings which float and move easily and uniformly, brackets which disappear from view and fused ends to offer a completely seamless aesthetic.

FLOAT | THE NEW STANDARD

Pictured: \varnothing 38mm (1½") Pole • Drum | \varnothing 30mm (1¾") Pole • Seamless Antique Brass - Satin

FLOAT

SEAMLESS

A unique new process fuses pole ends to pole in a truly seamless way.



FLOATING

Unique, smart design provides a beautiful, coated metal ring but with slick gliding functionality and a structured and uniform appearance.

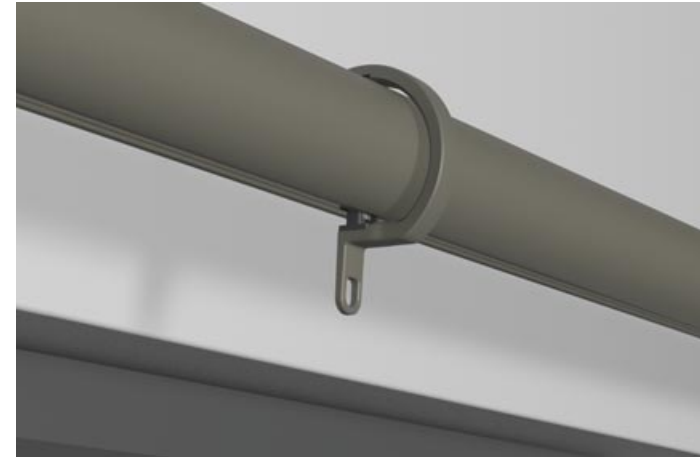

CEILING SKIMMING

Cleverly designed ceiling brackets mean rings move virtually flush to the ceiling. A new partition bracket also adds to the versatility of the collection.

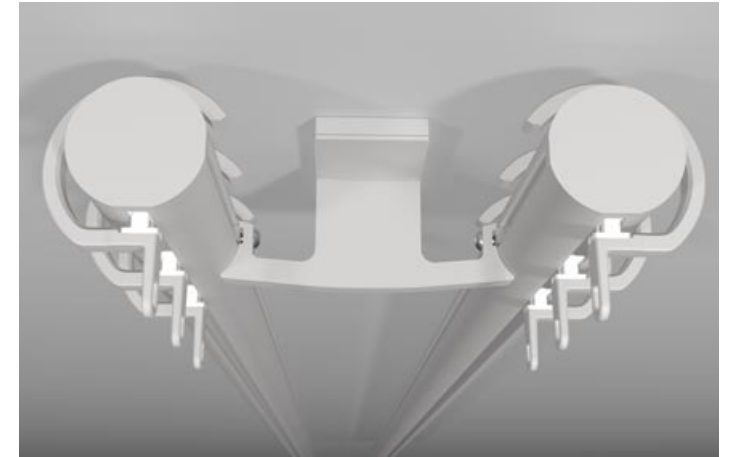

UNOBTRUSIVE

The bracket architecture is shared with Glide and Drive and keeps the front face of the pole clear of visible parts.

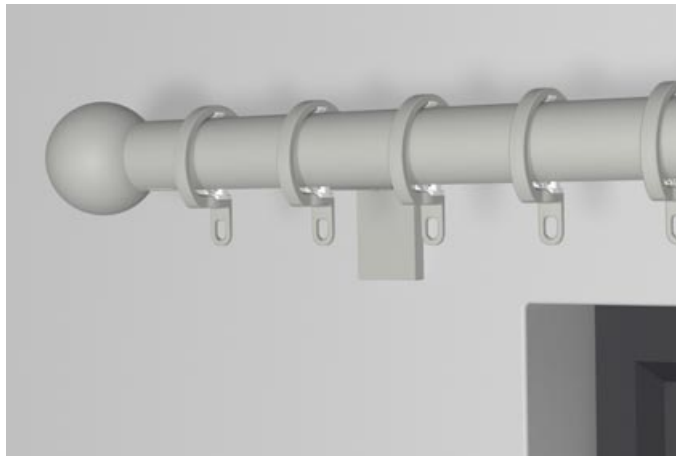

PRECISE

A new jointing system ensures perfect alignment between pole sections.

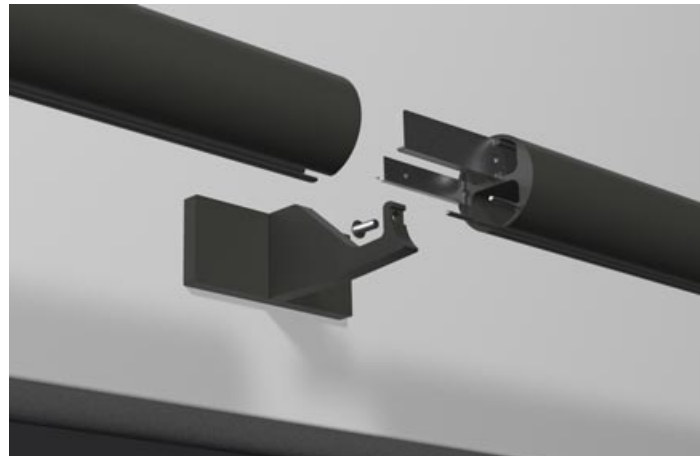

PERFECTED

Rings now pass brackets cleanly and easily even on the longest spans or through the most challenging bends.

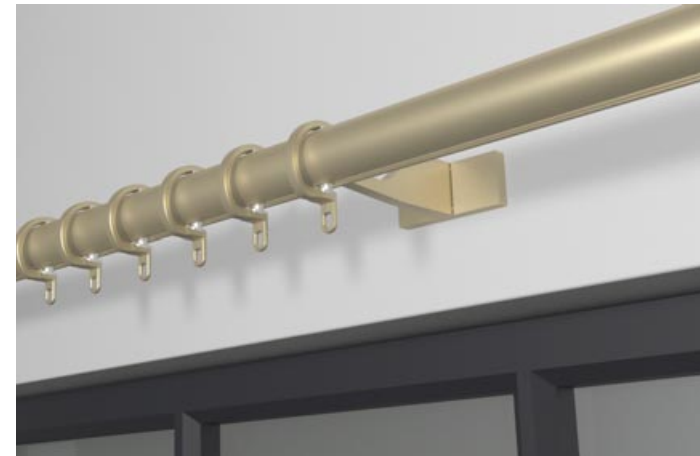

BENT TO SHAPE

The pole is designed to be accurately bent and curved to shape.

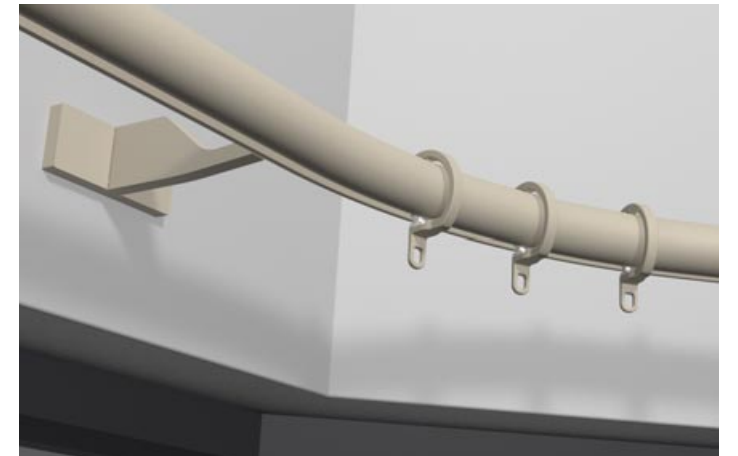

FINISHES

This newly extended palette of colours and finishes launches alongside Float, fitting the new collection to the mood of any scheme.

SHADES

A superb selection of opaque colours, all available in a choice of Matte, Satin or Gloss finish.



COAT OPTIONS



METALLICS

High metallic fleck coatings with most available in Satin and Gloss sheen levels.



ANODIC METALS

A flat metal colour group, with an anodised style surface texture.



Pictured left to right:
 ø30mm (1 3/16") Pole • Tulip • Champagne - Satin
 ø30mm (1 3/16") Pole • Orbic Grand • Platinum - Satin
 ø30mm (1 3/16") Pole • Ellipse • Antique Brass - Satin
 ø38mm (1 1/2") Pole • Oblique • Gold - Satin
 ø38mm (1 1/2") Pole • Drum • Bronze - Satin

FLOAT



Pictured top to bottom:
 ø30mm (1 3/16") Pole | Orbic • Bone - Matte | Seamless • Parchment - Matte
 Oblique • Oatmeal - Matte | Planar • Flint - Matte | Spheric • Raven - Matte

FINIALS

The fused ends of Float reflect the modern minimalism of the collection. As standard Float is presented with a Seamless end cap, with geometric finial forms added for a more decorative aesthetic.



Seamless® Supplied as standard

ø30mm (1 3/16") Inclusive Length 5mm (3/16")
 ø38mm (1 1/2") Inclusive Length 5mm (3/16")



Orbic

ø30mm (1 3/16") Inclusive Length 13mm (1/2")
 ø38mm (1 1/2") Inclusive Length 15mm (9/16")



Orbic Grand

ø30mm (1 3/16") Inclusive Length 13mm (1/2")
 ø38mm (1 1/2") Inclusive Length 15mm (9/16")



Drum

ø30mm (1 3/16") Inclusive Length 21mm (13/16")
 ø38mm (1 1/2") Inclusive Length 23mm (7/8")



Tulip

ø30mm (1 3/16") Inclusive Length 35mm (1 3/8")
 ø38mm (1 1/2") Inclusive Length 43mm (1 11/16")



Oblique

ø30mm (1 3/16") Inclusive Length 21mm (13/16")
 ø38mm (1 1/2") Inclusive Length 23mm (7/8")



Planar

ø30mm (1 3/16") Inclusive Length 25mm (1")
 ø38mm (1 1/2") Inclusive Length 29mm (1 1/8")



Ellipse

ø30mm (1 3/16") Inclusive Length 29mm (1 1/8")
 ø38mm (1 1/2") Inclusive Length 33mm (5/8")





Spheric

ø30mm (1 3/16") Inclusive Length 53mm (2 1/16")
 ø38mm (1 1/2") Inclusive Length 65mm (2 5/16")



© Please note that if this option is selected finials cannot be added at a later date.
 For full technical information, sizes and weights please download the specification guide - www.bradleycollection.com/specification-guides/

SINGLE BRACKETS

Side 	Diameter ø30mm (1 3/16") ø38mm (1 1/2")	Projection from wall to pole centre 60mm (2 3/8"), 100mm (4") 100mm (4")	Fixing plate size w30mm (1 3/16") x h70mm (2 3/4") w38mm (1 1/2") x h89mm (3 1/2")
Mid 	Diameter ø30mm (1 3/16") ø38mm (1 1/2")	Projection from wall to pole centre 60mm (2 3/8"), 100mm (4") 100mm (4")	Fixing plate size w70mm (2 3/4") x h30mm (1 3/16") w89mm (3 1/2") x h38mm (1 1/2")
Ceiling 	Diameter ø30mm (1 3/16") ø38mm (1 1/2")	Drop from ceiling to top of pole 7mm (1/4") 7mm (1/4")	Fixing plate size w70mm (2 3/4") x h30mm (1 3/16") w70mm (2 3/4") x h30mm (1 3/16")



DOUBLE BRACKETS

Side 	Diameter Fø30mm (1 3/16") Bø30mm (1 3/16") Fø38mm (1 1/2") Bø30mm (1 3/16") Fø38mm (1 1/2") Bø38mm (1 1/2")	Projection from wall to pole centre F160mm (6 5/16") B60mm (2 3/8") F160mm (6 5/16") B60mm (2 3/8") F160mm (6 5/16") B60mm (2 3/8")	Fixing plate size w57mm (2 1/4") x h114mm (4 1/2") w57mm (2 1/4") x h114mm (4 1/2") w57mm (2 1/4") x h114mm (4 1/2")
Mid 	Diameter Fø30mm (1 3/16") Bø30mm (1 3/16") Fø38mm (1 1/2") Bø30mm (1 3/16") Fø38mm (1 1/2") Bø38mm (1 1/2")	Projection from wall to pole centre F160mm (6 5/16") B60mm (2 3/8") F160mm (6 5/16") B60mm (2 3/8") F200mm (8") B100mm (4")	Fixing plate size w114mm (4 1/2") x h57mm (2 1/4") w114mm (4 1/2") x h57mm (2 1/4") w114mm (4 1/2") x h57mm (2 1/4")
Flush Partition 	Diameter Fø30mm (1 3/16") Bø30mm (1 3/16") Fø38mm (1 1/2") Bø38mm (1 1/2")	Drop from ceiling to top of pole 7mm (1/4") 7mm (1/4")	Fixing plate size w89mm (3 1/2") x h38mm (1 1/2") w89mm (3 1/2") x h38mm (1 1/2")

RECESS BRACKETS

Recess with hook stop 	Diameter ø30mm (1 3/16") ø38mm (1 1/2")	Depth off wall 10mm (3/8") 10mm (3/8")	Fixing plate size ø38mm (1 1/2") ø48mm (1 7/16")
---	--	---	---

CUSTOM BRACKETS

A bespoke design service is offered to ensure solutions in even the most challenging installations.



Custom Projection
Specify the exact projection needed.



Custom Fixing Plate
Relevant where space is restricted or weight is a concern.



Uplift
Helps negotiate cornice and similar architectural features.



Ceiling Brackets
Specify exact projection required from ceiling.



Angled Brackets
The solution for tight and awkward locations.

RINGS

Float rings are assembled with acetal gliders and liners, which ensure smooth operation and a consistent upright position for the rings. Float rings pass brackets flawlessly, by design.

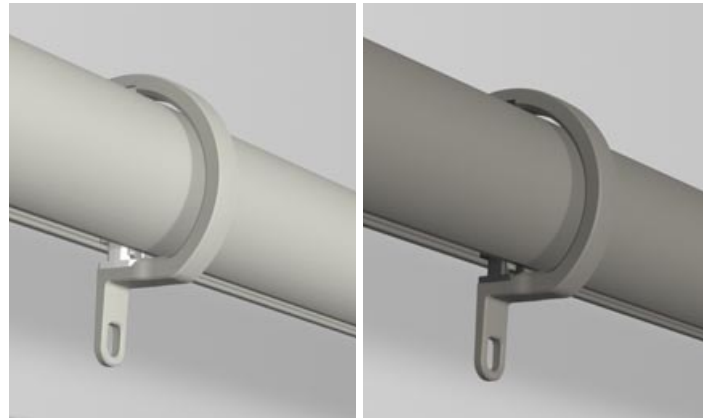

Diameter

ø30mm (1³/₁₆"")
ø38mm (1¹/₂"")

Ring drop from top of pole to bottom of ringlet

49mm (1⁵/₁₆"")
62mm (2⁷/₁₆"")

Gypsum Glider & Liner

Anthracite Glider & Liner

For finish colour coordination see the specification guide
www.bradleycollection.com/specification-guides/

POLES

Poles are cut, bent and curved to suit individual requirements. When calculating the length of your pole, remember to allow tolerance beyond the width of the frame for the curtains to stack back to the edge of the window.

Maximum pole length in one piece 4.0m (157").[Ⓜ]

Poles exceeding the maximum length will be cut into equal parts unless otherwise specified. A pole joiner will be supplied.



Size
ø30mm (1³/₁₆"")
ø38mm (1¹/₂"")

Maximum distance between brackets
1000mm (39")
1000mm (39")

ACCESSORIES

Ombres

Small



Internal projection from wall: 150mm (5⁷/₈"")
Fixing plate size: ø19mm (3³/₄"")

Grand



Internal projection from wall: 150mm (5⁷/₈"")
Fixing plate size: ø25mm (1")

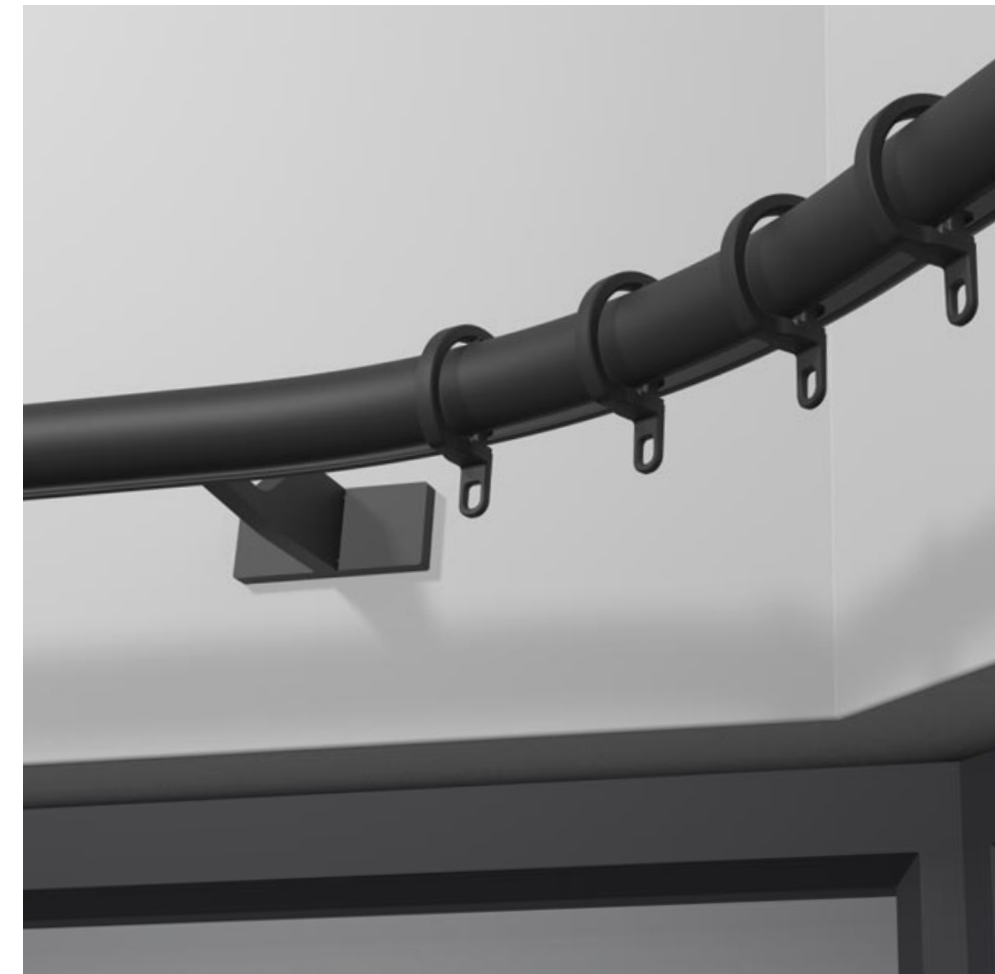

Draw Rod Seamless



Draw rod length:
1000mm (39³/₈"")
Custom lengths available to order